



METALFORM  
design

catalogo\_listino tecnico

01.2016

 MADE IN ITALY



# METALFORM design

catalogo\_listino tecnico  
01.2016

MADE IN ITALY

I PRODOTTI METALFORM DESIGN NASCONO IN ITALIA CON GUSTO E STILE ITALIANO



METALFORM  
design

# indice prodotti

catalogo tecnico  
**01.2016**

<b>rinnovo impianti</b>	6   7
cromotherapy	8   9
termo wood	10   11
termo rfx	12   13
termo motif	14   15
termo note	16   17
termo comb	18   19
termo loop	20   21
termo snake	22   23
termo cover	24   25
termo flower	26   27
termo puzzle	28   29
termo balls	30   31
termo tube	32   33
termo street	34   35
ombre	36   37
steel	38   39
cactus	40   41
tubone	42   43
luxor rfx	44   45
luxor	46   47
luxor doppio	48   49
luxor doppio rfx	50   51
luxor pm - ondalux	52   53
quadra t 15	54   55
quadra t doppio	56   57
quadrone	58   59
cili	60   61
easy	62   63
ultra - ultra s	64   65

ultra rfx - ultra rfx s	66   67
linea doppio - linea doppio s	68   69
linea doppio rfx - linea doppio s rfx	70   71
astra	72   73
astra s - astra x	74   75
roxy	76   77
tire	78   79
line	80   81
oslo	82   83
half circle	84   85
eye	86   87
border	88   89
asia	90   91
quadra s 10	92   93
quadra s 25	94   95
logic	96   97
logic cromo 19	98   99
radius	100   101
radius doppio	102   103
<b>realizzazioni</b>	104   105
<b>listini</b>	
listino accessori	108   112
listino attacchi	113   115
accessori attacchi	116
listino essenze linea wood	117
listino gamma colori	118   119
<b>condizioni di vendita</b>	120
<b>anagrafica clienti</b>	121
<b>corner espositivi</b>	122

rinnovo  
**impianti**

Tutti i modelli **Metalform Design** possono essere installati su impianti esistenti **senza interventi murari o idraulici.**

I termoarredo, le piastre radianti e gli scaldasalviette utilizzeranno gli stessi interassi che sono già presenti nella tua casa.





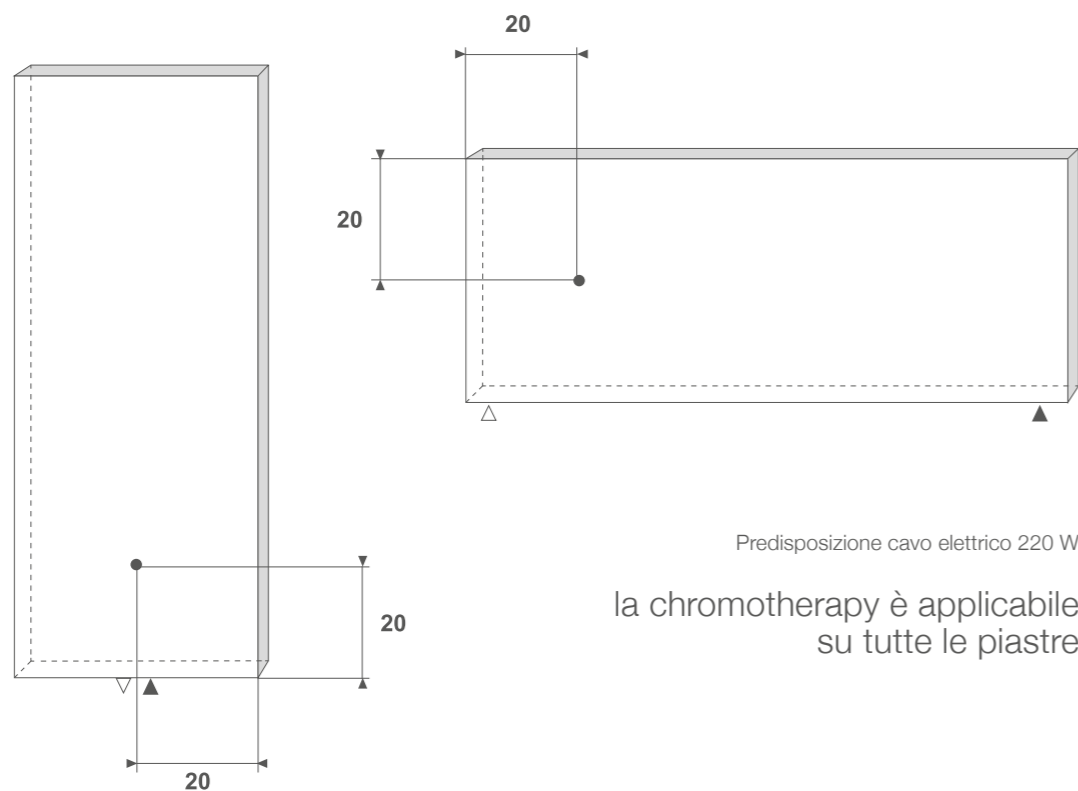

Predisposizione cavo elettrico 220 W

la chromotherapy è applicabile  
su tutte le piastre

### rosso

È il colore ideale per chi vuole calore, intensità e vitalità nel proprio ambiente

### blu

È un colore che rilassa, ispira, ristora, trasmette pace, senso di spazio ed etereo.

### viola

Energia di tipo "freddo". Colore "cosmico" dell'energia.

### arancione

Colore "caldo", induce serenità, entusiasmo, allegria.

### verde

È il colore della natura e simboleggia la vita, la freschezza, l'equilibrio e l'armonia.

### giallo

È il colore del sole, trasmette vitalità e ravviva l'atmosfera della stanza.

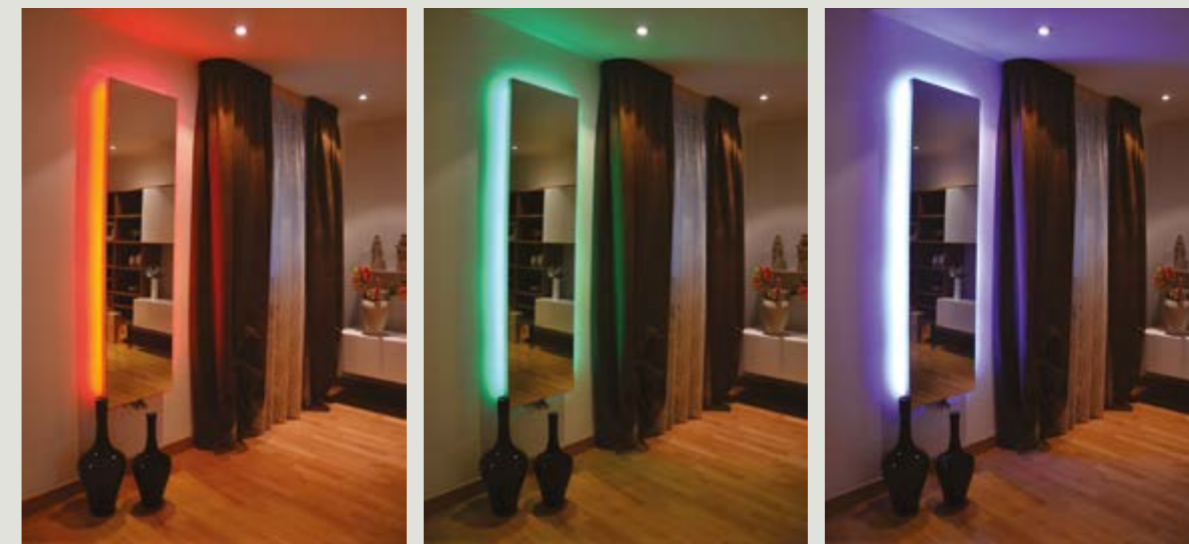

## la cromoterapia

I colori aiutano il corpo e la psiche a ritrovare il loro naturale equilibrio, e ha effetti fisici e psichici in grado di stimolare il corpo e calmare certi sintomi.

Ogni colore è associato a particolari caratteristiche psichiche e spirituali, e ha particolari effetti sul funzionamento dell'organismo.





Piastra in vero legno, per varianti essenze consultare la tabella pag. 117.  
Su richiesta fornitura con dimensioni e rese diverse da quelle indicate.

SUPERFICIE IN  
VERO LEGNO

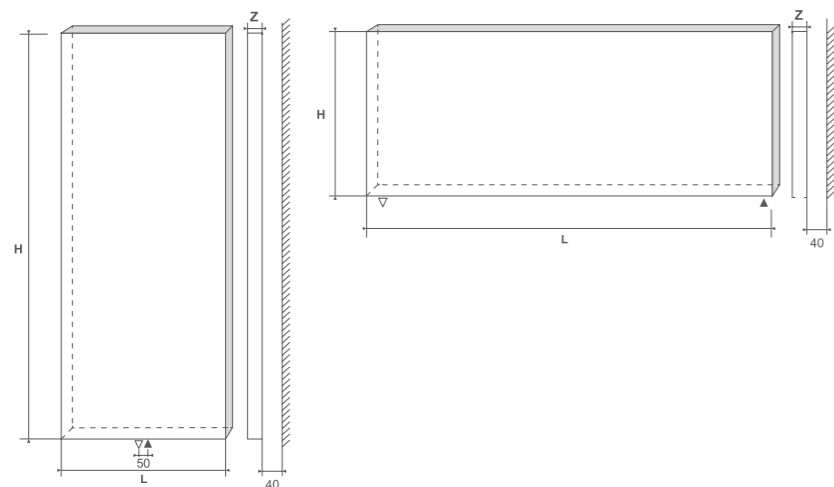

Cod. Art.	Dimensioni mm				Resa w Δt 50°C	
	H	L	I	Z		
RESE SINGOLE	*TRMCVR12047	1200	470	50	40	540
	*TRMCVR18047	1800	470	50	40	1067
	*TRMCVR18071	1800	710	50	40	1601
	*TRMCVR20047	2000	470	50	40	1178
	TRMCVR20071	2000	710	50	40	1766
RESE SUPERIORI	*TRMCVR12048-RS	1200	480	50	50	1100
	*TRMCVR18048-RS	1800	480	50	50	1500
	*TRMCVR18069-RS	1800	690	50	50	2200
	*TRMCVR20048-RS	2000	480	50	50	1680
	TRMCVR20069-RS	2000	690	50	50	2400

Optional	Dimensioni mm		
	H	L	Z
Portasciugamani piatto orizzontale (indicare lato)	100	40	35

MONTAGGIO ORIZZONTALE SENZA SUPPLEMENTO			
H	L	I	
470 - 480 - 690 - 710	1200	116,5	
470 - 480 - 690 - 710	1800	176,5	
470 - 480 - 690 - 710	2000	196,5	

N.B.: Su richiesta fornitura con dimensioni e rese diverse da quelle indicate.

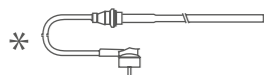

il modello è disponibile anche elettrico max  
1200 Watt



Supplemento per chromoterapy con  
retroilluminazione con variatore di luminosità  
telecomandato: € 1.400,00

NEW





Piastra in vero specchio.

Su richiesta fornitura con dimensioni e rese diverse da quelle indicate.

Mirror on request, supply sizes other than those specified and made.

SUPERFICIE IN  
VERO SPECCHIO

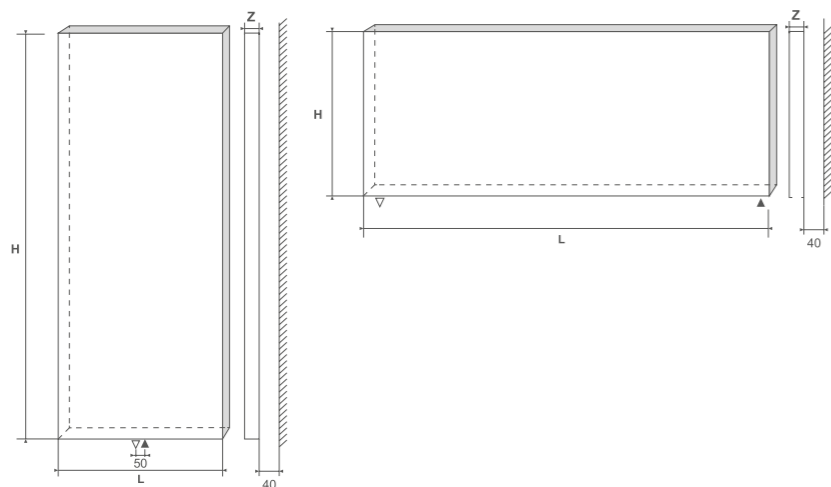

Cod. Art.	Dimensioni mm				Resa w Δt 50°C	
	H	L	I	Z		
<b>RESE SINGOLE</b>	*TRMCVR12047	1200	470	50	40	540
	*TRMCVR18047	1800	470	50	40	1067
	*TRMCVR18071	1800	710	50	40	1601
	*TRMCVR20047	2000	470	50	40	1178
	TRMCVR20071	2000	710	50	40	1766
<b>RESE SUPERIORI</b>	*TRMCVR12048-RS	1200	480	50	50	1100
	*TRMCVR18048-RS	1800	480	50	50	1500
	*TRMCVR18069-RS	1800	690	50	50	2200
	*TRMCVR20048-RS	2000	480	50	50	1680
	TRMCVR20069-RS	2000	690	50	50	2400

Optional	Dimensioni mm		
	H	L	Z
Portasciugamani piatto orizzontale (indicare lato)	100	40	35

MONTAGGIO ORIZZONTALE SENZA SUPPLEMENTO			
H	L	I	
470 - 480 - 690 - 710	1200	116,5	
470 - 480 - 690 - 710	1800	176,5	
470 - 480 - 690 - 710	2000	196,5	

N.B.: Su richiesta fornitura con dimensioni e rese diverse da quelle indicate.

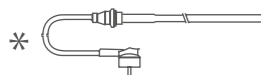

il modello è disponibile anche elettrico max  
1200 Watt



Supplemento per chromoterapy con  
retroilluminazione con variatore di luminosità  
telecomandato: € 1.400,00



Per i colori fuori standard consultare pag. 118-119.  
 Su richiesta fornitura con dimensioni e rese diverse da quelle indicate.  
 For out of standard colors consult page 118-119.  
 On request supply sizes other than those specified and made.

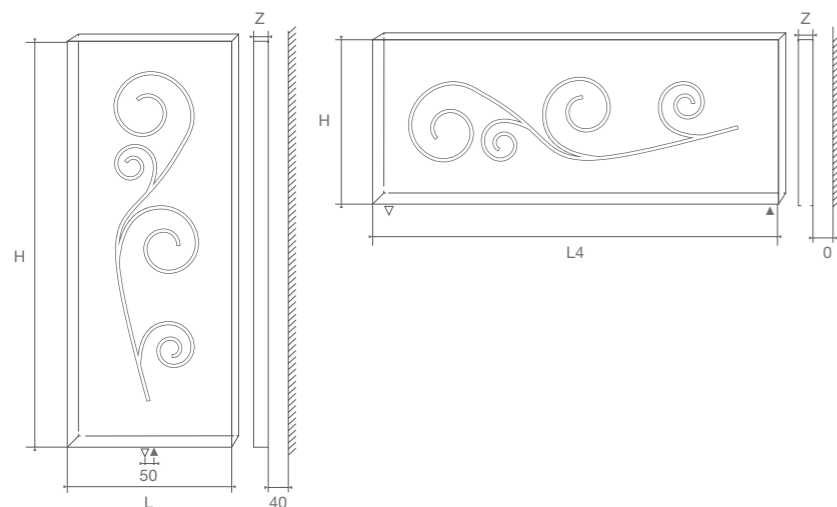

	Cod. Art.	Dimensioni mm				Resa w Δt 50°C
		H	L	I	Z	
RESE SINGOLE	*TRMCVR12047	1200	470	50	40	540
	*TRMCVR18047	1800	470	50	40	1067
	*TRMCVR18071	1800	710	50	40	1601
	*TRMCVR20047	2000	470	50	40	1178
	TRMCVR20071	2000	710	50	40	1766
RESE SUPERIORI	*TRMCVR12048-RS	1200	480	50	50	1100
	*TRMCVR18048-RS	1800	480	50	50	1500
	*TRMCVR18069-RS	1800	690	50	50	2200
	*TRMCVR20048-RS	2000	480	50	50	1680
	*TRMCVR20069-RS	2000	690	50	50	2400

Optional	Dimensioni mm		
	H	L	Z
Portasciugamani piatto orizzontale (indicare lato)	100	40	35

MONTAGGIO ORIZZONTALE SENZA SUPPLEMENTO			
H	L	I	
470 - 480 - 690 - 710	1200	116,5	
470 - 480 - 690 - 710	1800	176,5	
470 - 480 - 690 - 710	2000	196,5	

N.B.: Su richiesta fornitura con dimensioni e rese diverse da quelle indicate.

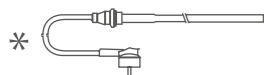

il modello è disponibile anche elettrico max 1200 Watt



Supplemento per chromotherapy con retroilluminazione con variatore di luminosità telecomandato: € 1.400,00

NEW





MADE IN ITALY

Per i colori fuori standard consultare pag. 118-119.

Su richiesta fornitura con dimensioni e rese diverse da quelle indicate.

For out of standard colors consult page 118-119.

On request supply sizes other than those specified and made.

SUPERFICIE IN  
VERO SPECCHIO

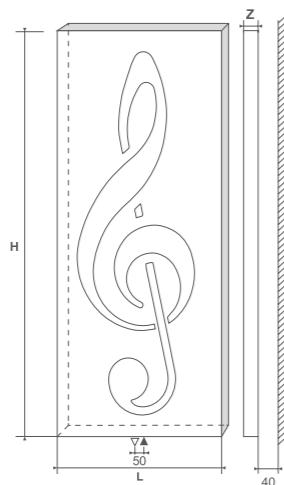

	Cod. Art.	Dimensioni mm				Resa w Δt 50°C
		H	L	I	Z	
RESE SINGOLE	*TRMCVR12047	1200	470	50	40	540
	*TRMCVR18047	1800	470	50	40	1067
	*TRMCVR18071	1800	710	50	40	1601
	*TRMCVR20047	2000	470	50	40	1178
	TRMCVR20071	2000	710	50	40	1766
RESE SUPERIORI	*TRMCVR12048-RS	1200	480	50	50	1100
	*TRMCVR18048-RS	1800	480	50	50	1500
	*TRMCVR18069-RS	1800	690	50	50	2200
	*TRMCVR20048-RS	2000	480	50	50	1680
	*TRMCVR20069-RS	2000	690	50	50	2400

Optional	Dimensioni mm		
	H	L	Z
Portasciugamani piatto orizzontale (indicare lato)	100	40	35

MONTAGGIO ORIZZONTALE SENZA SUPPLEMENTO			
H	L	I	
470 - 480 - 690 - 710	1200	116,5	
470 - 480 - 690 - 710	1800	176,5	
470 - 480 - 690 - 710	2000	196,5	

N.B.: Su richiesta fornitura con dimensioni e rese diverse da quelle indicate.

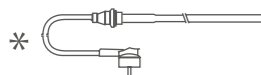

il modello è disponibile anche elettrico max  
1200 Watt



Supplemento per chromotherapy con  
retroilluminazione con variatore di luminosità  
telecomandato: € 1.400,00



Per i colori fuori standard consultare pag. 118-119.  
 Su richiesta fornitura con dimensioni e rese diverse da quelle indicate.  
 For out of standard colors consult page 118-119.  
 On request supply sizes other than those specified and made.

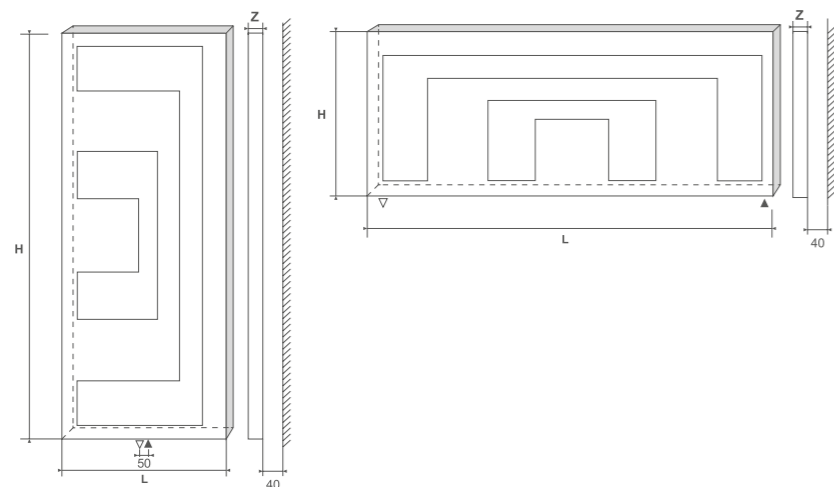

Cod. Art.	Dimensioni mm				Resa w Δt 50°C
	H	L	I	Z	
<b>RESE SINGOLE</b>					
*TRMCVR12047	1200	470	50	40	540
*TRMCVR18047	1800	470	50	40	1067
*TRMCVR18071	1800	710	50	40	1601
*TRMCVR20047	2000	470	50	40	1178
TRMCVR20071	2000	710	50	40	1766
<b>RESE SUPERIORI</b>					
*TRMCVR12048-RS	1200	480	50	50	1100
*TRMCVR18048-RS	1800	480	50	50	1500
*TRMCVR18069-RS	1800	690	50	50	2200
*TRMCVR20048-RS	2000	480	50	50	1680
*TRMCVR20069-RS	2000	690	50	50	2400

Optional	Dimensioni mm		
	H	L	Z
Portasciugamani piatto orizzontale (indicare lato)	100	40	35

MONTAGGIO ORIZZONTALE SENZA SUPPLEMENTO			
H	L	I	
470 - 480 - 690 - 710	1200	116,5	
470 - 480 - 690 - 710	1800	176,5	
470 - 480 - 690 - 710	2000	196,5	

N.B.: Su richiesta fornitura con dimensioni e rese diverse da quelle indicate.

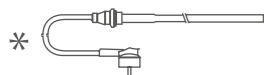

il modello è disponibile anche elettrico max 1200 Watt



Supplemento per chromoterapy con retroilluminazione con variatore di luminosità telecomandato: € 1.400,00

NEW





Per i colori fuori standard consultare pag. 118-119.  
 Su richiesta fornitura con dimensioni e rese diverse da quelle indicate.  
 For out of standard colors consult page 118-119.  
 On request supply sizes other than those specified and made.

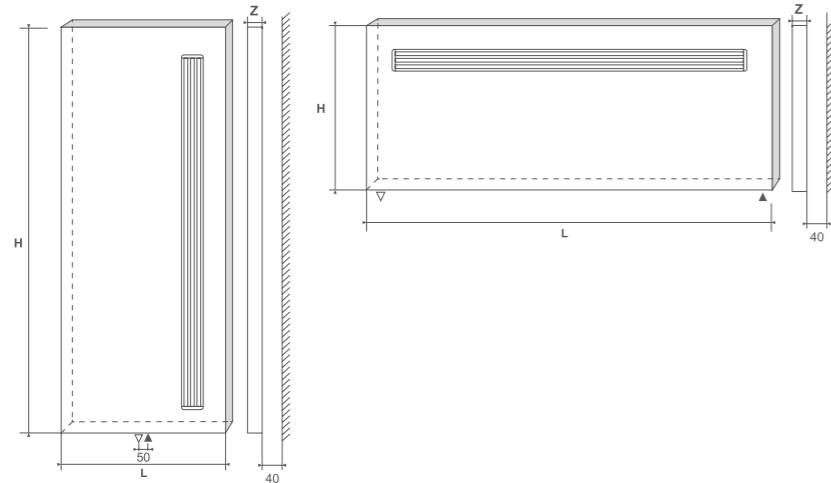

	Cod. Art.	Dimensioni mm				Resa w Δt 50°C
		H	L	I	Z	
<b>RESE SINGOLE</b>	*TRMCVR12047	1200	470	50	40	540
	*TRMCVR18047	1800	470	50	40	1067
	*TRMCVR18071	1800	710	50	40	1601
	*TRMCVR20047	2000	470	50	40	1178
	TRMCVR20071	2000	710	50	40	1766
<b>RESE SUPERIORI</b>	*TRMCVR12048-RS	1200	480	50	50	1100
	*TRMCVR18048-RS	1800	480	50	50	1500
	*TRMCVR18069-RS	1800	690	50	50	2200
	*TRMCVR20048-RS	2000	480	50	50	1680
	*TRMCVR20069-RS	2000	690	50	50	2400

Optional	Dimensioni mm		
	H	L	Z
Portasciugamani piatto orizzontale (indicare lato)	100	40	35

MONTAGGIO ORIZZONTALE SENZA SUPPLEMENTO			
H	L	I	
470 - 480 - 690 - 710	1200	116,5	
470 - 480 - 690 - 710	1800	176,5	
470 - 480 - 690 - 710	2000	196,5	

N.B.: Su richiesta fornitura con dimensioni e rese diverse da quelle indicate.

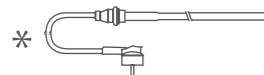

il modello è disponibile anche elettrico max  
1200 Watt



Supplemento per chromoterapy con  
retroilluminazione con variatore di luminosità  
telecomandato: € 1.400,00

NEW



MADE IN ITALY

Per i colori fuori standard consultare pag. 118-119.

Su richiesta fornitura con dimensioni e rese diverse da quelle indicate.

For out of standard colors consult page 118-119.

On request supply sizes other than those specified and made.

 SUPERFICIE IN  
VERO SPECCHIO

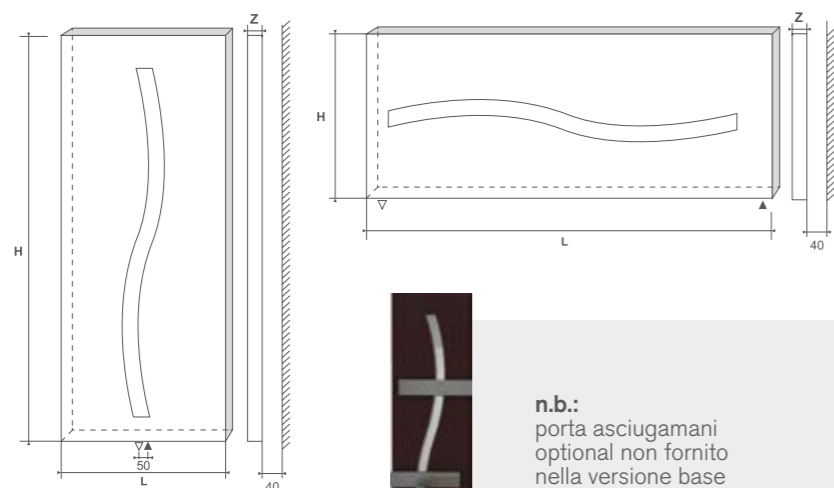

**n.b.:**  
porta asciugamani  
optional non fornito  
nella versione base

	Cod. Art.	Dimensioni mm				Resa w Δt 50°C
		H	L	I	Z	
<b>RESE SINGOLE</b>	*TRMCVR12047	1200	470	50	40	540
	*TRMCVR18047	1800	470	50	40	1067
	*TRMCVR18071	1800	710	50	40	1601
	*TRMCVR20047	2000	470	50	40	1178
	TRMCVR20071	2000	710	50	40	1766
<b>RESE SUPERIORI</b>	*TRMCVR12048-RS	1200	480	50	50	1100
	*TRMCVR18048-RS	1800	480	50	50	1500
	*TRMCVR18069-RS	1800	690	50	50	2200
	*TRMCVR20048-RS	2000	480	50	50	1680
	*TRMCVR20069-RS	2000	690	50	50	2400

Optional	Dimensioni mm		
	H	L	Z
Portasciugamani piatto orizzontale (indicare lato)	100	40	35

MONTAGGIO ORIZZONTALE SENZA SUPPLEMENTO			
H	L	I	
470 - 480 - 690 - 710	1200	116,5	
470 - 480 - 690 - 710	1800	176,5	
470 - 480 - 690 - 710	2000	196,5	

N.B.: Su richiesta fornitura con dimensioni e rese diverse da quelle indicate.

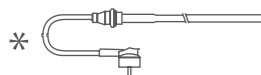

\* il modello è disponibile anche elettrico max  
1200 Watt



Supplemento per chromoterapy con  
retroilluminazione con variatore di luminosità  
telecomandato: € 1.400,00



NEW





MADE IN ITALY

Per i colori fuori standard consultare pag. 118-119.

Su richiesta fornitura con dimensioni e rese diverse da quelle indicate.

For out of standard colors consult page 118-119.

On request supply sizes other than those specified and made.

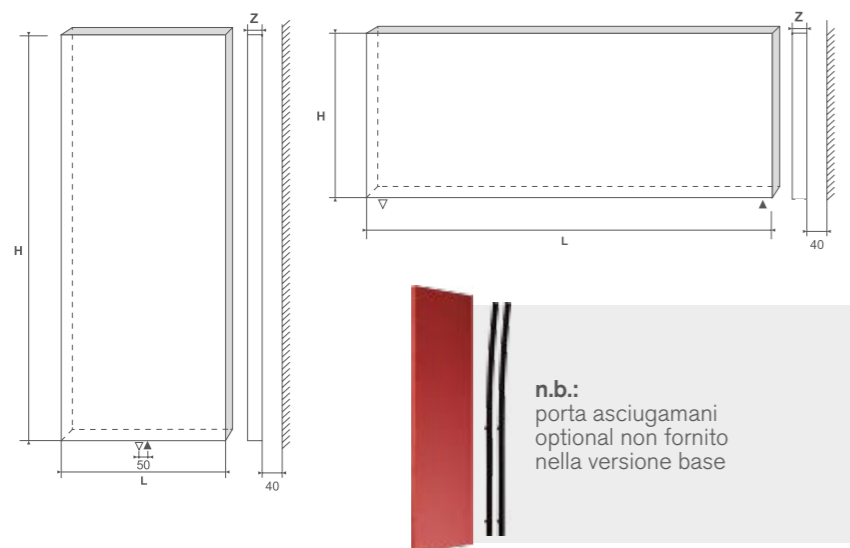

	Cod. Art.	Dimensioni mm				Resa w Δt 50°C
		H	L	I	Z	
<b>RESE SINGOLE</b>	*TRMCVR12047	1200	470	50	40	540
	*TRMCVR18047	1800	470	50	40	1067
	*TRMCVR18071	1800	710	50	40	1601
	*TRMCVR20047	2000	470	50	40	1178
	TRMCVR20071	2000	710	50	40	1766
<b>RESE SUPERIORI</b>	*TRMCVR12048-RS	1200	480	50	50	1100
	*TRMCVR18048-RS	1800	480	50	50	1500
	*TRMCVR18069-RS	1800	690	50	50	2200
	*TRMCVR20048-RS	2000	480	50	50	1680
	*TRMCVR20069-RS	2000	690	50	50	2400

Optional	Dimensioni mm		
	H	L	Z
Portasciugamani piatto orizzontale (indicare lato)	100	40	35

MONTAGGIO ORIZZONTALE SENZA SUPPLEMENTO			
H	L	I	
470 - 480 - 690 - 710	1200	116,5	
470 - 480 - 690 - 710	1800	176,5	
470 - 480 - 690 - 710	2000	196,5	

N.B.: Su richiesta fornitura con dimensioni e rese diverse da quelle indicate.

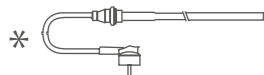

il modello è disponibile anche elettrico max  
1200 Watt



Supplemento per chromotherapy con  
retroilluminazione con variatore di luminosità  
telecomandato: € 1.400,00



Per i colori fuori standard consultare pag. 118-119.  
 Su richiesta fornitura con dimensioni e rese diverse da quelle indicate.  
 For out of standard colors consult page 118-119.  
 On request supply sizes other than those specified and made.

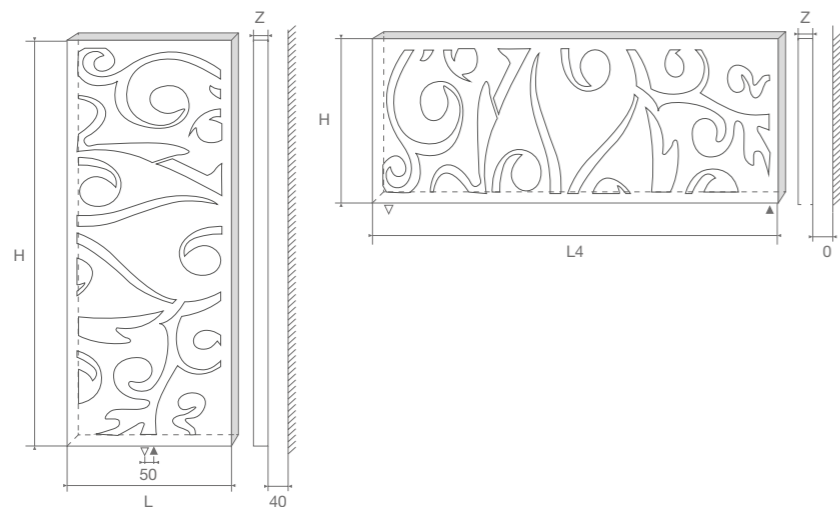

	Cod. Art.	Dimensioni mm				Resa w Δt 50°C
		H	L	I	Z	
<b>RESE SINGOLE</b>	*TRMCVR12047	1200	470	50	40	540
	*TRMCVR18047	1800	470	50	40	1067
	*TRMCVR18071	1800	710	50	40	1601
	*TRMCVR20047	2000	470	50	40	1178
	TRMCVR20071	2000	710	50	40	1766
<b>RESE SUPERIORI</b>	*TRMCVR12048-RS	1200	480	50	50	1100
	*TRMCVR18048-RS	1800	480	50	50	1500
	*TRMCVR18069-RS	1800	690	50	50	2200
	*TRMCVR20048-RS	2000	480	50	50	1680
	*TRMCVR20069-RS	2000	690	50	50	2400

Optional	Dimensioni mm		
	H	L	Z
Portasciugamani piatto orizzontale (indicare lato)	100	40	35

MONTAGGIO ORIZZONTALE SENZA SUPPLEMENTO			
H	L	I	
470 - 480 - 690 - 710	1200	116,5	
470 - 480 - 690 - 710	1800	176,5	
470 - 480 - 690 - 710	2000	196,5	

N.B.: Su richiesta fornitura con dimensioni e rese diverse da quelle indicate.

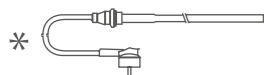

\* il modello è disponibile anche elettrico max 1200 Watt



Supplemento per chromoterapy con retroilluminazione con variatore di luminosità telecomandato: € 1.400,00





MADE IN ITALY

Per i colori fuori standard consultare pag. 118-119.

Su richiesta fornitura con dimensioni e rese diverse da quelle indicate.

For out of standard colors consult page 118-119.

On request supply sizes other than those specified and made.

SUPERFICIE IN  
VERO SPECCHIO

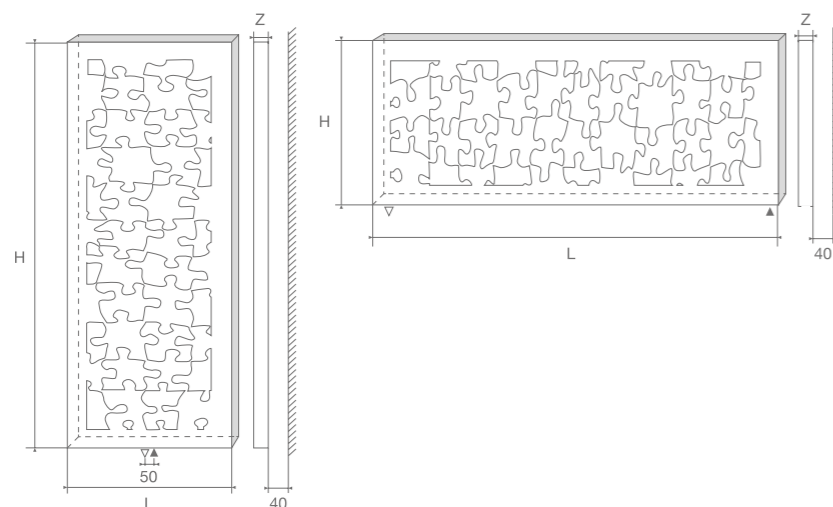

	Cod. Art.	Dimensioni mm				Resa w Δt 50°C
		H	L	I	Z	
<b>RESE SINGOLE</b>	*TRMCVR12047	1200	470	50	40	540
	*TRMCVR18047	1800	470	50	40	1067
	*TRMCVR18071	1800	710	50	40	1601
	*TRMCVR20047	2000	470	50	40	1178
	TRMCVR20071	2000	710	50	40	1766
<b>RESE SUPERIORI</b>	*TRMCVR12048-RS	1200	480	50	50	1100
	*TRMCVR18048-RS	1800	480	50	50	1500
	*TRMCVR18069-RS	1800	690	50	50	2200
	*TRMCVR20048-RS	2000	480	50	50	1680
	*TRMCVR20069-RS	2000	690	50	50	2400

Optional	Dimensioni mm		
	H	L	Z
Portasciugamani piatto orizzontale (indicare lato)	100	40	35

MONTAGGIO ORIZZONTALE SENZA SUPPLEMENTO			
H	L	I	
470 - 480 - 690 - 710	1200	116,5	
470 - 480 - 690 - 710	1800	176,5	
470 - 480 - 690 - 710	2000	196,5	

N.B.: Su richiesta fornitura con dimensioni e rese diverse da quelle indicate.

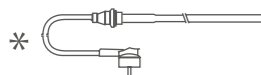

il modello è disponibile anche elettrico max  
1200 Watt



Supplemento per chromotherapy con  
retroilluminazione con variatore di luminosità  
telecomandato: € 1.400,00



Per i colori fuori standard consultare pag. 118-119.  
 Su richiesta fornitura con dimensioni e rese diverse da quelle indicate.  
 For out of standard colors consult page 118-119.  
 On request supply sizes other than those specified and made.

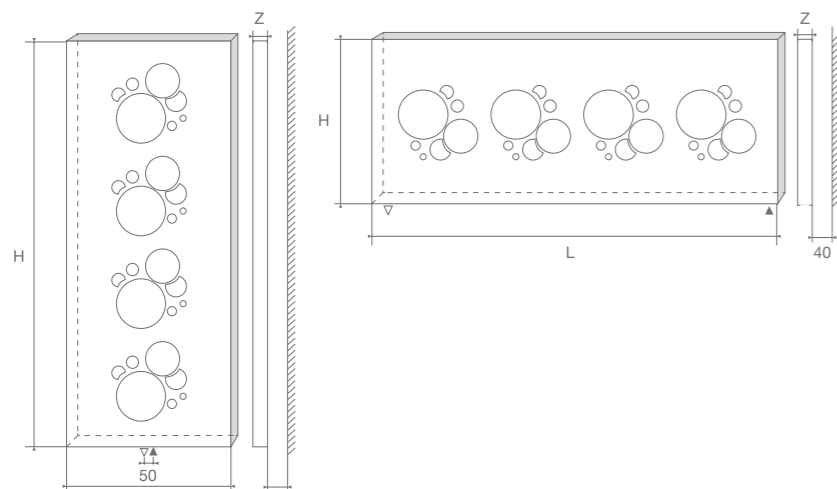

Cod. Art.	Dimensioni mm				Resa w Δt 50°C
	H	L	I	Z	
<b>RESE SINGOLE</b>					
*TRMCVR12047	1200	470	50	40	540
*TRMCVR18047	1800	470	50	40	1067
*TRMCVR18071	1800	710	50	40	1601
*TRMCVR20047	2000	470	50	40	1178
TRMCVR20071	2000	710	50	40	1766
<b>RESE SUPERIORI</b>					
*TRMCVR12048-RS	1200	480	50	50	1100
*TRMCVR18048-RS	1800	480	50	50	1500
*TRMCVR18069-RS	1800	690	50	50	2200
*TRMCVR20048-RS	2000	480	50	50	1680
*TRMCVR20069-RS	2000	690	50	50	2400

Optional	Dimensioni mm		
	H	L	Z
Portasciugamani piatto orizzontale (indicare lato)	100	40	35

MONTAGGIO ORIZZONTALE SENZA SUPPLEMENTO		
H	L	I
470 - 480 - 690 - 710	1200	116,5
470 - 480 - 690 - 710	1800	176,5
470 - 480 - 690 - 710	2000	196,5

N.B.: Su richiesta fornitura con dimensioni e rese diverse da quelle indicate.

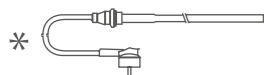

il modello è disponibile anche elettrico max 1200 Watt



Supplemento per chromoterapy con retroilluminazione con variatore di luminosità telecomandato: € 1.400,00





Per i colori fuori standard consultare pag. 118-119.  
 Su richiesta fornitura con dimensioni e rese diverse da quelle indicate.  
 For out of standard colors consult page 118-119.  
 On request supply sizes other than those specified and made.

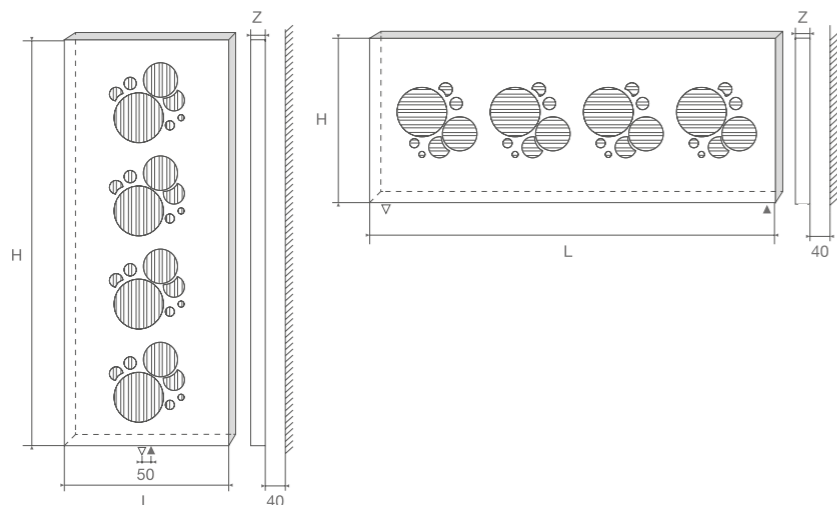

Cod. Art.	Dimensioni mm				Resa w Δt 50°C
	H	L	I	Z	
<b>RESE SINGOLE</b>					
*TRMCVR12047	1200	470	50	40	540
*TRMCVR18047	1800	470	50	40	1067
*TRMCVR18071	1800	710	50	40	1601
*TRMCVR20047	2000	470	50	40	1178
TRMCVR20071	2000	710	50	40	1766
<b>RESE SUPERIORI</b>					
*TRMCVR12048-RS	1200	480	50	50	1100
*TRMCVR18048-RS	1800	480	50	50	1500
*TRMCVR18069-RS	1800	690	50	50	2200
*TRMCVR20048-RS	2000	480	50	50	1680
*TRMCVR20069-RS	2000	690	50	50	2400

Optional	Dimensioni mm		
	H	L	Z
Portasciugamani piatto orizzontale (indicare lato)	100	40	35

MONTAGGIO ORIZZONTALE SENZA SUPPLEMENTO			
H	L	I	
470 - 480 - 690 - 710	1200	116,5	
470 - 480 - 690 - 710	1800	176,5	
470 - 480 - 690 - 710	2000	196,5	

N.B.: Su richiesta fornitura con dimensioni e rese diverse da quelle indicate.

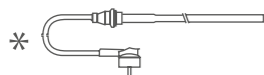

il modello è disponibile anche elettrico max  
1200 Watt



Supplemento per chromoterapy con  
retroilluminazione con variatore di luminosità  
telecomandato: € 1.400,00

NEW





Per i colori fuori standard consultare pag. 118-119.  
 Su richiesta fornitura con dimensioni e rese diverse da quelle indicate.  
 For out of standard colors consult page 118-119.  
 On request supply sizes other than those specified and made.

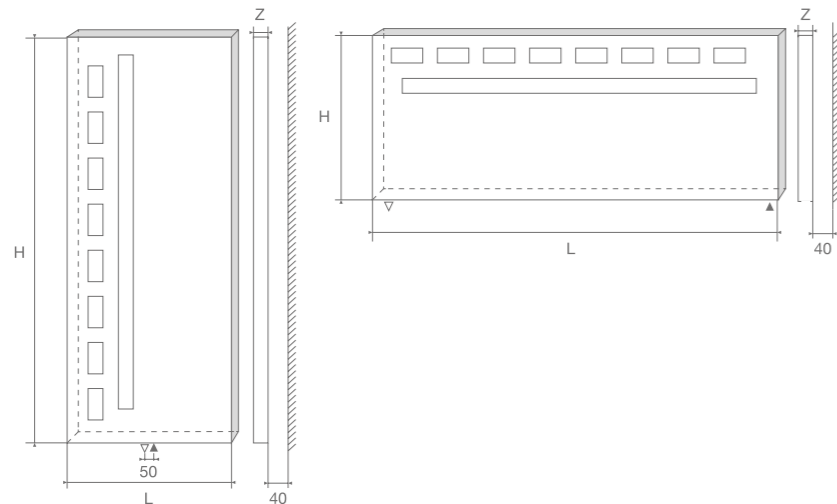

	Cod. Art.	Dimensioni mm				Resa w Δt 50°C
		H	L	I	Z	
<b>RESE SINGOLE</b>	*TRMCVR12047	1200	470	50	40	540
	*TRMCVR18047	1800	470	50	40	1067
	*TRMCVR18071	1800	710	50	40	1601
	*TRMCVR20047	2000	470	50	40	1178
	TRMCVR20071	2000	710	50	40	1766
<b>RESE SUPERIORI</b>	*TRMCVR12048-RS	1200	480	50	50	1100
	*TRMCVR18048-RS	1800	480	50	50	1500
	*TRMCVR18069-RS	1800	690	50	50	2200
	*TRMCVR20048-RS	2000	480	50	50	1680
	*TRMCVR20069-RS	2000	690	50	50	2400

Optional	Dimensioni mm		
	H	L	Z
Portasciugamani piatto orizzontale (indicare lato)	100	40	35

MONTAGGIO ORIZZONTALE SENZA SUPPLEMENTO			
H	L	I	
470 - 480 - 690 - 710	1200	116,5	
470 - 480 - 690 - 710	1800	176,5	
470 - 480 - 690 - 710	2000	196,5	

N.B.: Su richiesta fornitura con dimensioni e rese diverse da quelle indicate.

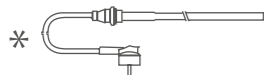

il modello è disponibile anche elettrico max 1200 Watt



Supplemento per chromoterapy con retroilluminazione con variatore di luminosità telecomandato: € 1.400,00





# ombre

MADE IN ITALY

Per i colori fuori standard consultare pag. 118-119.  
 Su richiesta fornitura con dimensioni e rese diverse da quelle indicate.  
 For out of standard colors consult page 118-119.  
 On request supply sizes other than those specified and made.

SUPERFICIE IN  
 VERO SPECCHIO

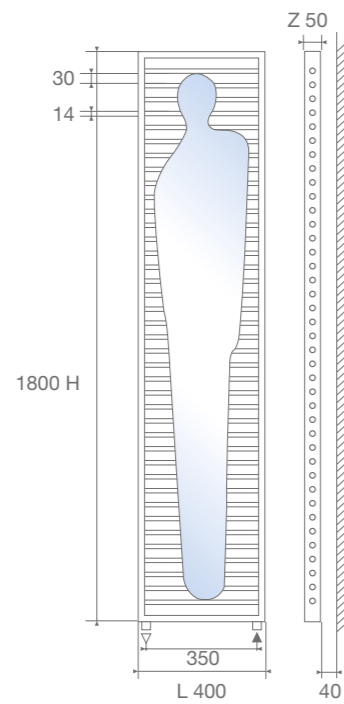

Dimensioni mm			Resa w Δt 50°C	Resa Kcal Δt 60°C
H	L	I		
1800	400	350	739	802

N.B.: Su richiesta fornitura con dimensioni e rese diverse da quelle indicate.

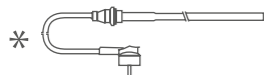

il modello è disponibile anche elettrico max  
 1200 Watt

NEW



# steel

MADE IN ITALY

Per i colori fuori standard consultare pag. 118-119.  
 Su richiesta fornitura con dimensioni e rese diverse da quelle indicate.  
 For out of standard colors consult page 118-119.  
 On request supply sizes other than those specified and made.

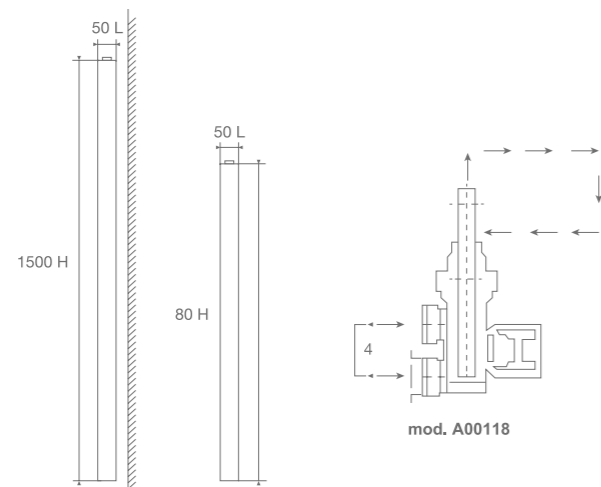

Art.	Dimensioni mm			Resa w $\Delta t$ 50°C
	H	L	I	
Steel 8	800	50	3,5	90
Steel 15	1500	50	3,5	168

N.B.: Su richiesta fornitura con dimensioni e rese diverse da quelle indicate.

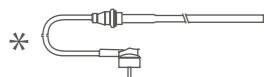

\* il modello è disponibile anche elettrico max 1200 Watt





# cactus

MADE IN ITALY

Per i colori fuori standard consultare pag. 118-119.  
 Su richiesta fornitura con dimensioni e rese diverse da quelle indicate.  
 For out of standard colors consult page 118-119.  
 On request supply sizes other than those specified and made.

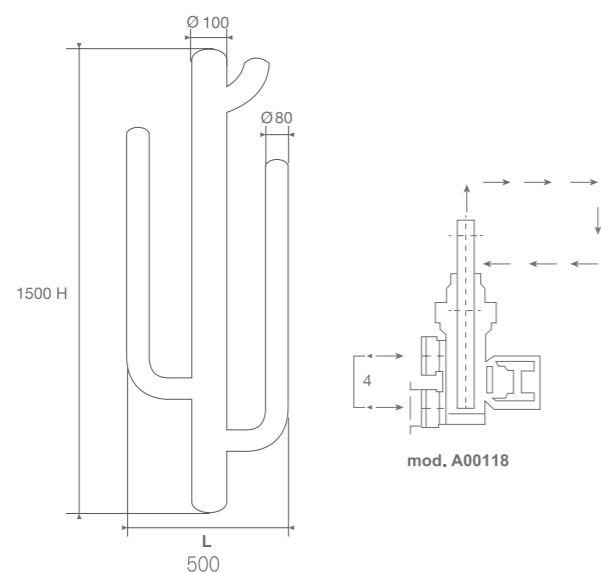

Cod. Art.	Dimensioni mm			Resa w $\Delta t$ 50°C
	H	L	I	
CTS15050	1500	500	35	730

N.B.: Su richiesta fornitura con dimensioni e rese diverse da quelle indicate.

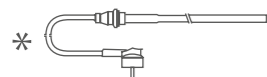

il modello è disponibile anche elettrico max 1200 Watt



# tubone

MADE IN ITALY

Per i colori fuori standard consultare pag. 118-119.  
 Su richiesta fornitura con dimensioni e rese diverse da quelle indicate.  
 For out of standard colors consult page 118-119.  
 On request supply sizes other than those specified and made.

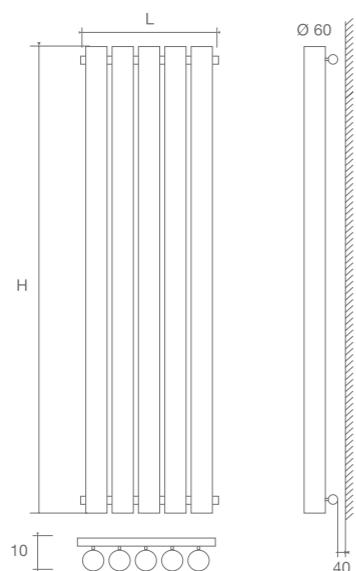

N. elem.	L	800		1500	
		Resa w Δt 50°C	Resa Kcal Δt 60°C	Resa w Δt 50°C	Resa Kcal Δt 60°C
2	133	160	172	282	304
4	280	320	345	564	608
6	425	480	518	846	912
8	490	640	691	1128	1216
10	610	800	864	1410	1520

N. elem.	L	1800		2000	
		Resa w Δt 50°C	Resa Kcal Δt 60°C	Resa w Δt 50°C	Resa Kcal Δt 60°C
2	133	336	362	372	400
4	280	672	724	744	800
6	425	1008	1086	1166	1200
8	490	1344	1448	1488	1600
10	610	1680	1810	1860	2000

N.B.: Su richiesta fornitura con dimensioni e rese diverse da quelle indicate.

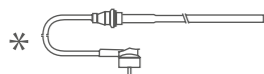

il modello è disponibile anche elettrico max 1200 Watt

NEW





Per i colori fuori standard consultare pag. 118-119.  
 Su richiesta fornitura con dimensioni e rese diverse da quelle indicate.  
 For out of standard colors consult page 118-119.  
 On request supply sizes other than those specified and made.

 SUPERFICIE IN  
 VERO SPECCHIO

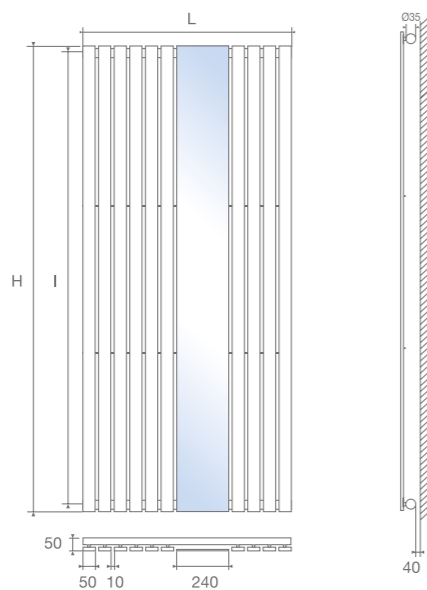

N. elementi	H I	1800		2000	
		Resa w $\Delta t$ 50°C	Resa Kcal $\Delta t$ 60°C	Resa w $\Delta t$ 50°C	Resa Kcal $\Delta t$ 60°C
6	590	800	869	883	959
8	710	1067	1159	1178	1279
10	830	1334	1449	1472	1599
12	950	1601	1739	1766	1919
14	1070	1868	2029	2061	2239
16	1190	2134	2318	2355	2558

N.B.: Su richiesta fornitura con dimensioni e rese diverse da quelle indicate.

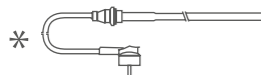

il modello è disponibile anche elettrico max  
 1200 Watt



Per i colori fuori standard consultare pag. 118-119.  
 Su richiesta fornitura con dimensioni e rese diverse da quelle indicate.  
 For out of standard colors consult page 118-119.  
 On request supply sizes other than those specified and made.

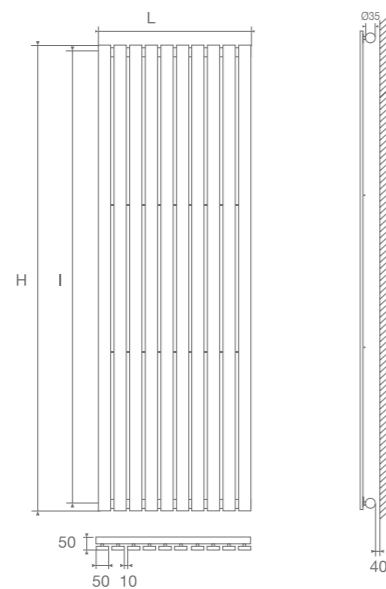

N. elem.	L	H 800		I 1500		I 1800		I 2000	
		Resa w Δt 50°C	Resa Kcal Δt 60°C	Resa w Δt 50°C	Resa Kcal Δt 60°C	Resa w Δt 50°C	Resa Kcal Δt 60°C	Resa w Δt 50°C	Resa Kcal Δt 60°C
6	360	387	421	676	724	800	869	883	959
8	470	516	661	902	979	1067	1159	1178	1279
10	590	646	701	1127	1224	1334	1449	1472	1599
12	710	774	841	1352	1469	1601	1739	1766	1919
14	830	903	981	1578	1714	1868	2029	2061	2239
16	950	1032	1122	1803	1958	2134	2318	2355	2558
18	1070	1161	1262	2029	2203	2401	2608	2650	2878
20	1190	1290	1402	2254	2448	2668	2898	2944	3198

N.B.: Su richiesta fornitura con dimensioni e rese diverse da quelle indicate.





Per i colori fuori standard consultare pag. 118-119.  
 Su richiesta fornitura con dimensioni e rese diverse da quelle indicate.  
 For out of standard colors consult page 118-119.  
 On request supply sizes other than those specified and made.

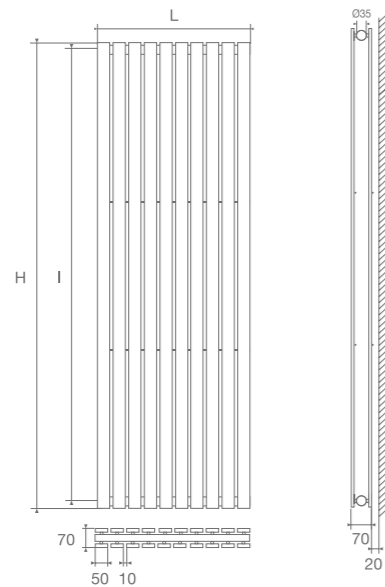

H		800		1500		1800		2000	
I		740		1440		1740		1940	
N. elem.	L	Resa w Δt 50°C	Resa Kcal Δt 60°C	Resa w Δt 50°C	Resa Kcal Δt 60°C	Resa w Δt 50°C	Resa Kcal Δt 60°C	Resa w Δt 50°C	Resa Kcal Δt 60°C
4 + 4	230	438	477	766	831	906	984	999	1086
6 + 6	350	657	715	1149	1247	1360	1477	1500	1630
8 + 8	470	877	953	1533	1664	1813	1970	2000	2174

N.B.: Su richiesta fornitura con dimensioni e rese diverse da quelle indicate.

**NEW**



# luxor doppio rfx

MADE IN ITALY

Per i colori fuori standard consultare pag. 118-119.  
 Su richiesta fornitura con dimensioni e rese diverse da quelle indicate.  
 For out of standard colors consult page 118-119.  
 On request supply sizes other than those specified and made.

 SUPERFICIE IN  
 VERO SPECCHIO

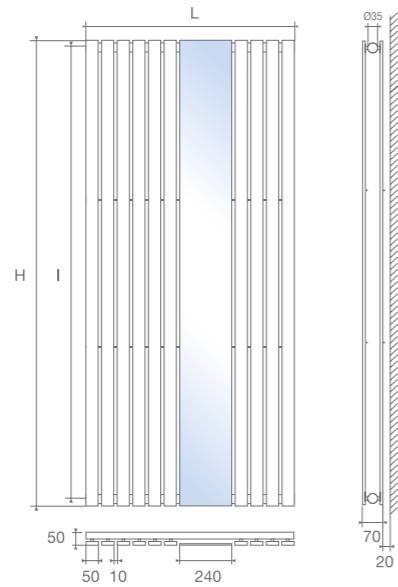

N. elem.	L	1800		2000	
		Resa w $\Delta t$ 50°C	Resa Kcal $\Delta t$ 60°C	Resa w $\Delta t$ 50°C	Resa Kcal $\Delta t$ 60°C
4 + 4	480	906	984	999	1086
6 + 6	600	1360	1477	1500	1630
8 + 8	720	1813	1970	2000	2174

N.B.: Su richiesta fornitura con dimensioni e rese diverse da quelle indicate.

NEW





# luxor pm + ondalux

MADE IN ITALY

Per i colori fuori standard consultare pag. 118-119.  
 Su richiesta fornitura con dimensioni e rese diverse da quelle indicate.  
 For out of standard colors consult page 118-119.  
 On request supply sizes other than those specified and made.

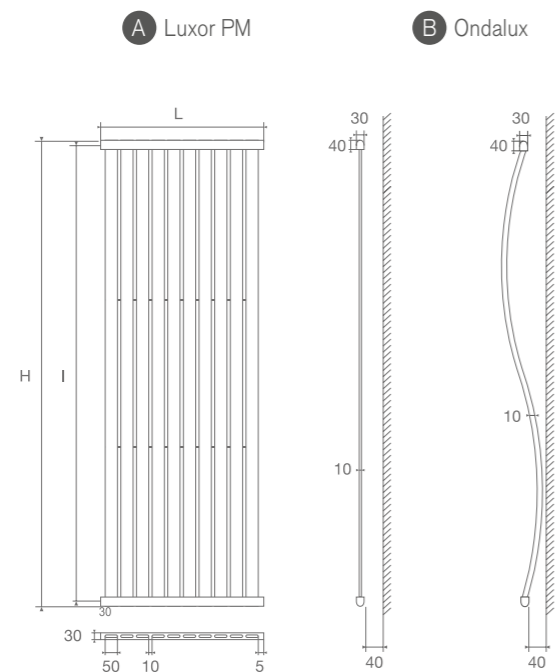

LUXOR PM									
H		800		1500		1800		2000	
I		740		1440		1740		1940	
N. elem.	L	Resa w Δt 50°C	Resa Kcal Δt 60°C	Resa w Δt 50°C	Resa Kcal Δt 60°C	Resa w Δt 50°C	Resa Kcal Δt 60°C	Resa w Δt 50°C	Resa Kcal Δt 60°C
6	360	387	421	676	724	800	869	883	959
8	470	516	661	902	979	1067	1159	1178	1279
10	590	646	701	1127	1224	1334	1449	1472	1599
12	710	774	841	1352	1469	1601	1739	1766	1919
14	830	903	981	1578	1714	1868	2029	2061	2239
16	950	1032	1122	1803	1958	2134	2318	2355	2558
18	1070	1161	1262	2029	2203	2401	2608	2650	2878
20	1190	1290	1402	2555	2448	2668	2898	2944	3198

ONDALUX							
H		1500		1800		2000	
I		1440		1740		1940	
N. elem.	L	Resa w Δt 50°C	Resa Kcal Δt 60°C	Resa w Δt 50°C	Resa Kcal Δt 60°C	Resa w Δt 50°C	Resa Kcal Δt 60°C
6	360	676	734	800	869	883	959
8	470	902	979	1067	1159	1178	1279
10	590	1127	1224	1334	1449	1472	1599
12	710	1352	1469	1601	1739	1766	1919
14	830	1578	1714	1868	2029	2061	2239
16	950	1803	1958	2134	2318	2355	2558
18	1070	2029	2203	2401	2608	2650	2878
20	1190	2254	2448	2668	2898	2944	3198

N.B.: Su richiesta fornitura con dimensioni e rese diverse da quelle indicate.





# quadra t 15

MADE IN ITALY

Per i colori fuori standard consultare pag. 118-119.  
 Su richiesta fornitura con dimensioni e rese diverse da quelle indicate.  
 For out of standard colors consult page 118-119.  
 On request supply sizes other than those specified and made.

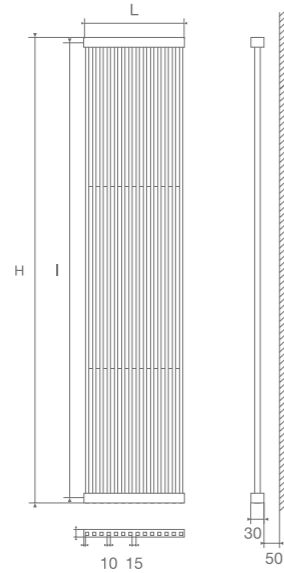

N. elem.	L	800		1500		1800		2000	
		Resa w Δt 50°C	Resa Kcal Δt 60°C	Resa w Δt 50°C	Resa Kcal Δt 60°C	Resa w Δt 50°C	Resa Kcal Δt 60°C	Resa w Δt 50°C	Resa Kcal Δt 60°C
10	270	273	297	479	520	567	616	624	678
12	322	328	356	575	624	680	739	749	814
14	374	382	416	671	728	794	862	874	949
16	426	437	475	766	832	907	986	998	1085
18	478	491	535	862	936	1021	1109	1123	1220
20	530	546	594	958	1040	1134	1232	1248	1356
22	582	601	653	1054	1144	1247	1355	1373	1492
24	634	655	713	1150	1248	1361	1478	1498	1627
26	686	710	772	1245	1352	1474	1602	1622	1763
28	738	764	832	1341	1456	1588	1725	1747	1898
30	790	819	891	1437	1560	1701	1848	1872	2034

N.B.: Su richiesta fornitura con dimensioni e rese diverse da quelle indicate.





# quadra t doppio

MADE IN ITALY

Per i colori fuori standard consultare pag. 118-119.  
 Su richiesta fornitura con dimensioni e rese diverse da quelle indicate.  
 For out of standard colors consult page 118-119.  
 On request supply sizes other than those specified and made.

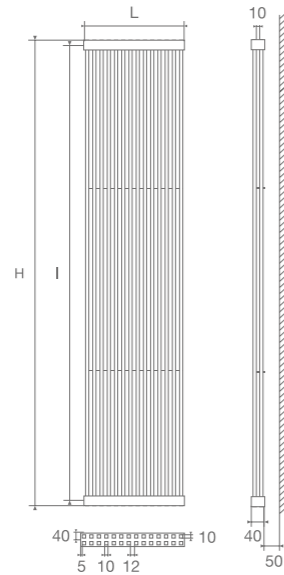

N. elem.	L	1500		1800		2000	
		Resa w Δt 50°C	Resa Kcal Δt 60°C	Resa w Δt 50°C	Resa Kcal Δt 60°C	Resa w Δt 50°C	Resa Kcal Δt 60°C
24	270	690	871	816	1028	907	1143
28	310	795	1003	953	1200	1058	1333
32	360	910	1149	1089	1372	1210	1525
36	400	1025	1294	1225	1543	1361	1715
40	450	1140	1440	1361	1715	1512	1905
44	490	1250	1578	1497	1886	1663	2095
48	530	1365	1723	1633	2058	1814	2285
52	570	1480	1869	1769	2229	1966	2477
56	620	1590	2007	1905	2400	2117	2667
60	660	1705	2152	2041	2571	2268	2857
64	710	1820	2298	2177	2743	2419	3048
68	750	1930	2436	2313	2914	2570	3238
72	800	2045	2582	2449	3086	2722	3430

N.B.: Su richiesta fornitura con dimensioni e rese diverse da quelle indicate.



# quadrone

MADE IN ITALY

Per i colori fuori standard consultare pag. 118-119.  
 Su richiesta fornitura con dimensioni e rese diverse da quelle indicate.  
 For out of standard colors consult page 118-119.  
 On request supply sizes other than those specified and made.

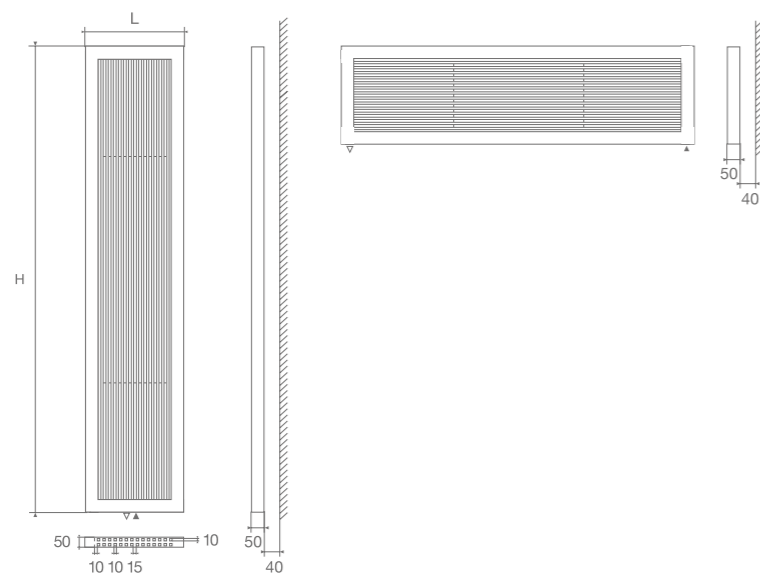

H	I	1500		1800		2000	
		50	50	50	50	50	50
N. elem.	L	Resa w Δt 50°C	Resa Kcal Δt 60°C	Resa w Δt 50°C	Resa Kcal Δt 60°C	Resa w Δt 50°C	Resa Kcal Δt 60°C
16+2	310	874	1183	1048	1320	1163	1466
26+2	400	1127	1423	1347	1697	1497	1886
32+2	480	1375	1735	1646	2074	1829	2300
42+2	570	1628	2055	1945	2450	2160	2700

H	L	I
310/400/480/570	1500	1450
310/400/480/570	1800	1750
310/400/480/570	2000	1950

N.B.: Su richiesta fornitura con dimensioni e rese diverse da quelle indicate.

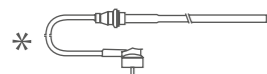

il modello è disponibile anche elettrico max 1200 Watt

NEW





Per i colori fuori standard consultare pag. 118-119.  
 Su richiesta fornitura con dimensioni e rese diverse da quelle indicate.  
 For out of standard colors consult page 118-119.  
 On request supply sizes other than those specified and made.

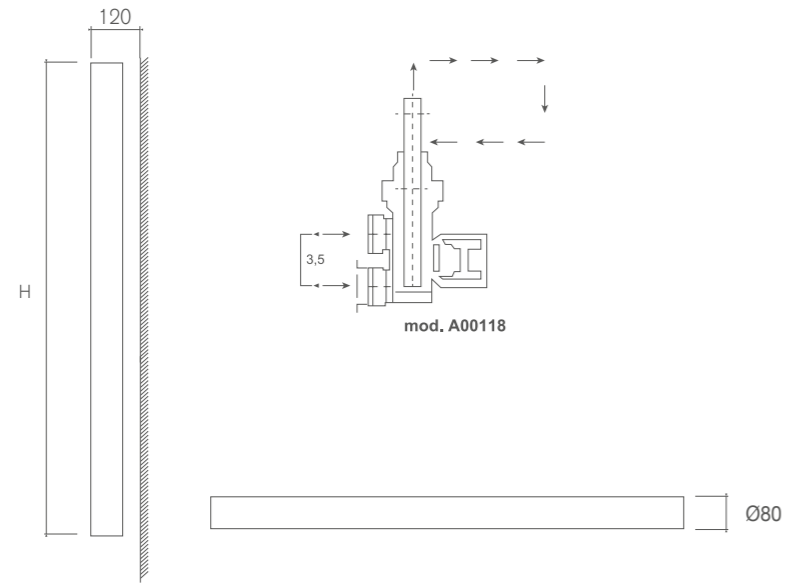

H	Ø tubo	l	Bianco
			Resa w Δt 50°C
800	80	35	120
1200	80	35	180
1500	80	35	225
1800	80	35	270

N.B.: Su richiesta fornitura con dimensioni e rese diverse da quelle indicate.

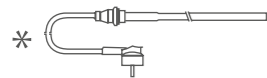

\* il modello è disponibile anche elettrico max 1200 Watt

NEW

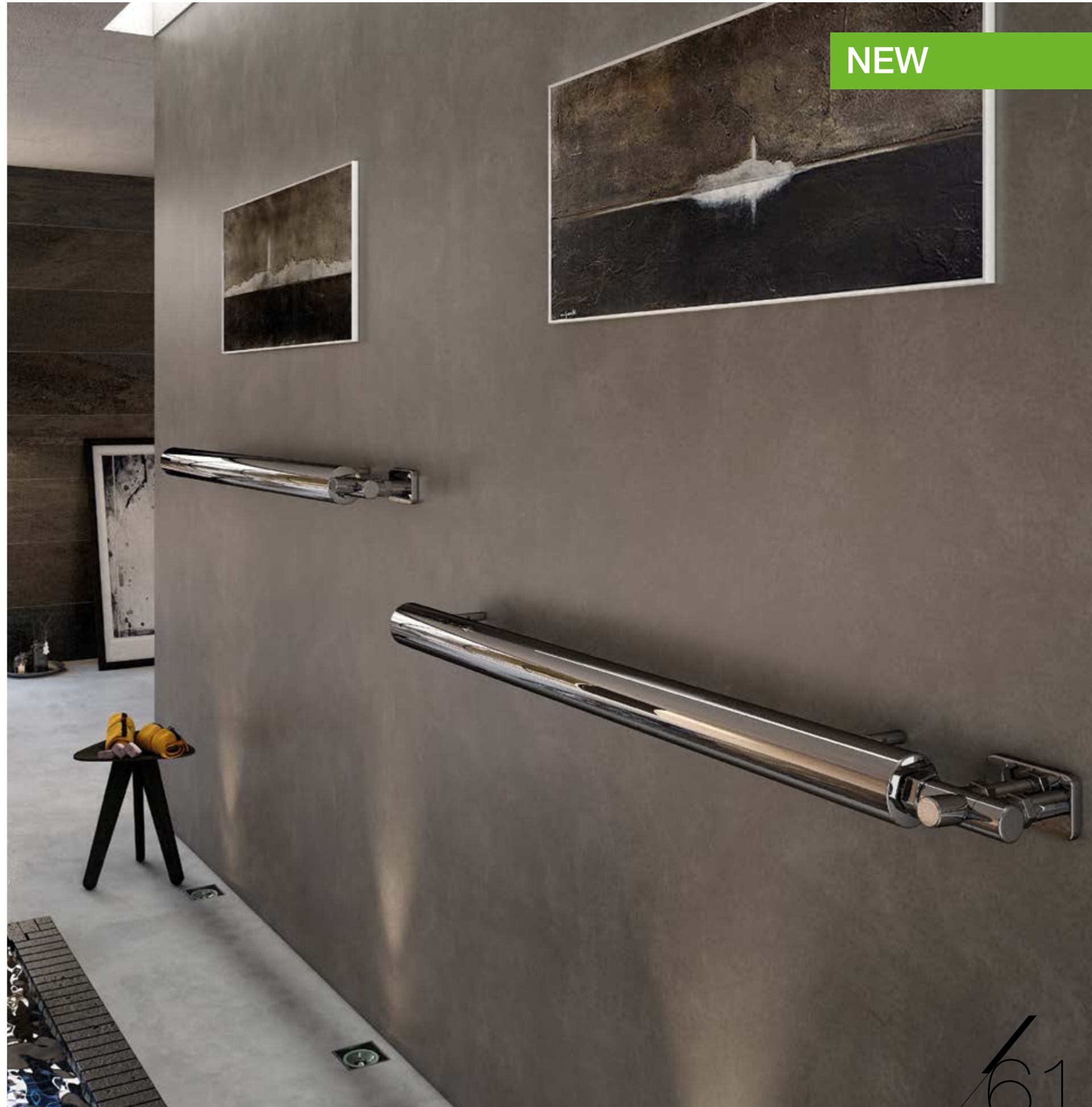



easy

MADE IN ITALY

Per i colori fuori standard consultare pag. 118-119.  
 Su richiesta fornitura con dimensioni e rese diverse da quelle indicate.  
 For out of standard colors consult page 118-119.  
 On request supply sizes other than those specified and made.

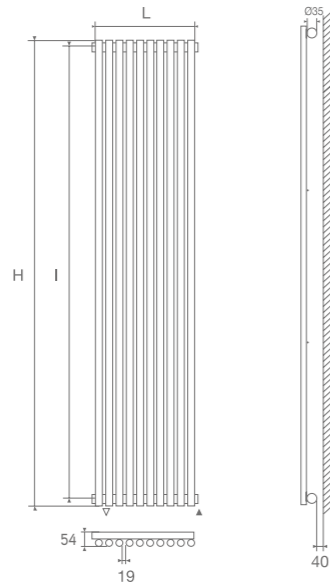

N. elem.	H 2000		Resa w $\Delta t$ 50°C
	L	I	
8	265	168	600
10	321	225	750
12	377	280	900
14	433	336	1050
16	489	392	1180
18	545	448	1350
20	601	504	1500

N.B.: Gli interassi su questo modello sono esclusivamente sottostanti come da misure riportate in tabella. Su richiesta è possibile produrre radiatori, piastre radianti e scaldasalviette con misure diverse dalle standard.

METALFORM  
design

NEW





# ultra + ultra s

MADE IN ITALY

Per i colori fuori standard consultare pag. 118-119.  
 Su richiesta fornitura con dimensioni e rese diverse da quelle indicate.  
 For out of standard colors consult page 118-119.  
 On request supply sizes other than those specified and made.

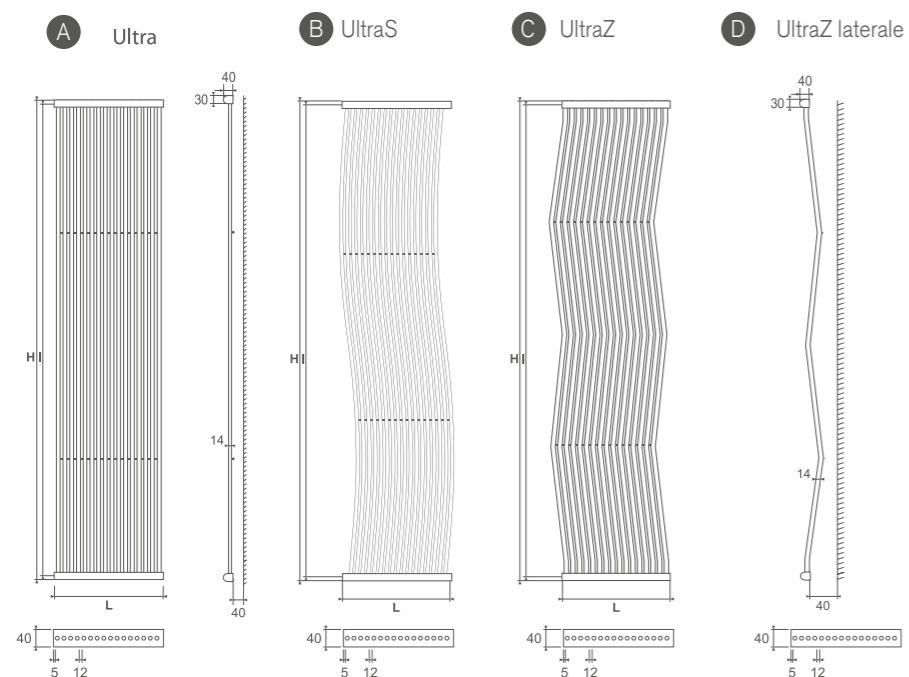

N. elem.	L	1800		2000	
		Resa w $\Delta t$ 50°C	Resa Kcal $\Delta t$ 60°C	Resa w $\Delta t$ 50°C	Resa Kcal $\Delta t$ 60°C
10	270	567	616	624	678
12	322	680	739	749	814
14	374	794	862	874	949
16	426	907	986	998	1085
18	478	1021	1109	1123	1220
20	530	1134	1232	1248	1356
22	582	1247	1355	1373	1492
24	634	1361	1478	1498	1627
26	686	1474	1602	1622	1763
28	738	1588	1725	1747	1898
30	790	1701	1848	1872	2034
32	842	1814	1971	1997	2170
34	894	1928	2094	2122	2305
36	946	2041	2218	2246	2441
38	998	2155	2341	2371	2576
40	1050	2268	2464	2496	2712

N.B.: Su richiesta fornitura con dimensioni e rese diverse da quelle indicate.



# ultra rfx + ultra rfx s

MADE IN ITALY

Per i colori fuori standard consultare pag. 118-119.  
 Su richiesta fornitura con dimensioni e rese diverse da quelle indicate.  
 For out of standard colors consult page 118-119.  
 On request supply sizes other than those specified and made.

SUPERFICIE IN  
**VERO SPECCHIO**

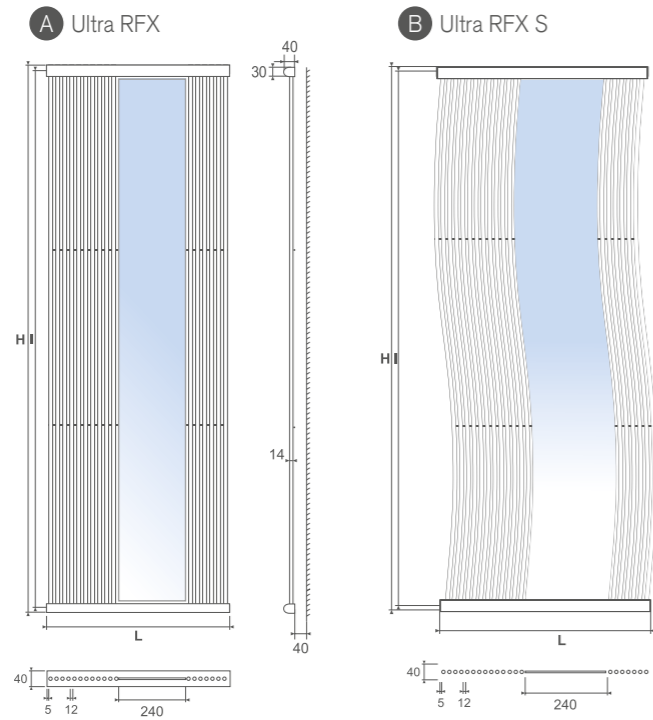

N. elem.	L	1800		2000	
		Resa w $\Delta t$ 50°C	Resa Kcal $\Delta t$ 60°C	Resa w $\Delta t$ 50°C	Resa Kcal $\Delta t$ 60°C
14	620	794	862	874	949
16	670	907	986	998	1085
18	722	1021	1109	1123	1220
20	774	1134	1232	1248	1356
22	826	1247	1355	1373	1492
24	878	1361	1478	1498	1627
26	930	1474	1602	1622	1763
28	982	1588	1725	1768	1898
30	1034	1701	1848	1872	2034

N.B.: Su richiesta fornitura con dimensioni e rese diverse da quelle indicate.





# linea doppio + linea doppio s

MADE IN ITALY

Per i colori fuori standard consultare pag. 118-119.  
 Su richiesta fornitura con dimensioni e rese diverse da quelle indicate.  
 For out of standard colors consult page 118-119.  
 On request supply sizes other than those specified and made.

A Linea doppio

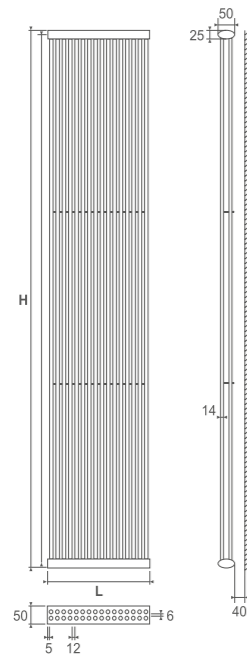

B Linea doppio rev.S

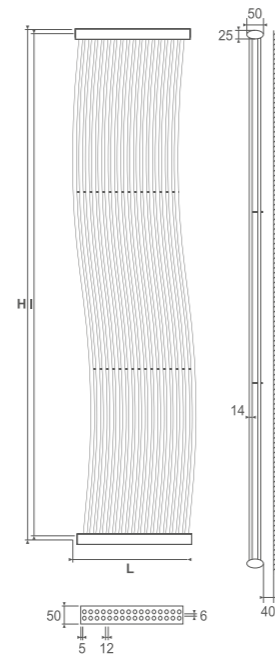

N. elem.	L	H 800		H 1500		H 1800		H 2000	
		Resa w Δt 50°C	Resa Kcal Δt 60°C	Resa w Δt 50°C	Resa Kcal Δt 60°C	Resa w Δt 50°C	Resa Kcal Δt 60°C	Resa w Δt 50°C	Resa Kcal Δt 60°C
20	270	410	450	719	780	851	924	936	1017
24	322	492	534	863	936	1020	1109	1124	1221
28	374	573	624	1007	1092	1191	1293	1311	1424
32	426	656	713	1149	1248	1361	1479	1497	1628
36	478	797	803	1293	1404	1532	1664	1685	1830
40	530	819	891	1437	1560	1701	1848	1872	2094
44	582	902	980	1581	1716	1871	2033	2060	2238
48	634	983	1070	1725	1872	2042	2217	2247	2441
52	686	1065	1158	1868	2028	2211	2403	2433	2645
56	738	1146	1248	2012	2184	2382	2588	2621	2847
60	790	1229	1337	2156	2340	2552	2772	2808	3051
64	842	1311	1425	2300	2496	2721	2957	2996	3255
68	894	1392	1515	2444	2656	2892	3141	3183	3458
72	946	1475	1604	2586	2808	3062	3327	3369	3662
76	998	1556	1694	2730	2964	3233	3512	3557	3864
80	1050	1638	1782	2874	3120	3402	3696	3744	4068

N.B.: Su richiesta fornitura con dimensioni e rese diverse da quelle indicate.



linea doppio rfx + linea doppio rfx s

MADE IN ITALY

Per i colori fuori standard consultare pag. 118-119.

Su richiesta fornitura con dimensioni e rese diverse da quelle indicate.

For out of standard colors consult page 118-119.

On request supply sizes other than those specified and made.

SUPERFICIE IN  
VERO SPECCHIO

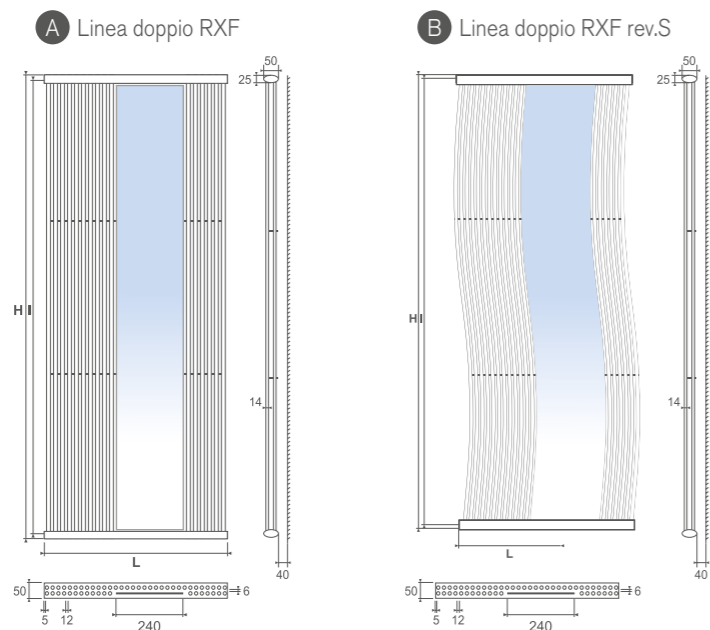

H		1500		1800		2000	
I		1465		1765		1965	
N. elem.	L	Resa w $\Delta t$ 50°C	Resa Kcal $\Delta t$ 60°C	Resa w $\Delta t$ 50°C	Resa Kcal $\Delta t$ 60°C	Resa w $\Delta t$ 50°C	Resa Kcal $\Delta t$ 60°C
20	520	719	780	851	924	936	1017
24	572	863	936	1020	1109	1124	1221
28	624	1007	1092	1191	1293	1311	1424
32	676	1149	1248	1361	1479	1497	1628
36	728	1293	1404	1532	1664	1685	1830
40	780	1437	1560	1701	1848	1872	2094
44	832	1581	1716	1871	2033	2060	2238
48	884	1725	1872	2042	2217	2247	2441
52	936	1868	2028	2211	2403	2433	2645
56	988	2012	2184	2382	2588	2621	2847
60	1040	2156	2340	2552	2772	2808	3051
64	1092	2300	2496	2721	2957	2996	3255
68	1144	2444	2656	2892	3141	3183	3458
72	1196	2586	2808	3062	3327	3369	3662
76	1248	2730	2964	3233	3512	3557	3864
80	1300	2874	3120	3402	3696	3744	4068

N.B.: Su richiesta fornitura con dimensioni e rese diverse da quelle indicate.



NEW



Per i colori fuori standard consultare pag. 118-119.  
 Su richiesta fornitura con dimensioni e rese diverse da quelle indicate.  
 For out of standard colors consult page 118-119.  
 On request supply sizes other than those specified and made.

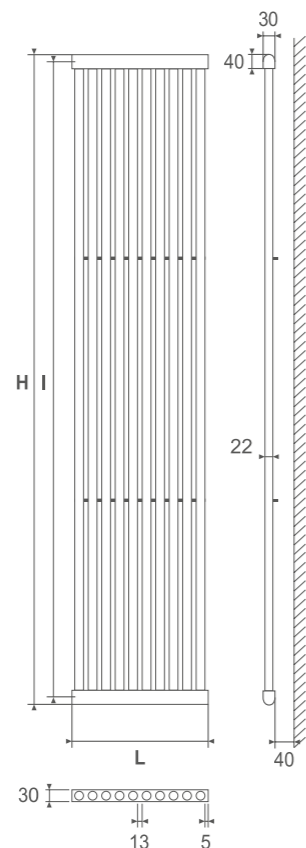

H	800		1500		1800		2000		
I	765		1465		1765		1965		
N. elem.	L	Resa w Δt 50°C	Resa Kcal Δt 60°C	Resa w Δt 50°C	Resa Kcal Δt 60°C	Resa w Δt 50°C	Resa Kcal Δt 60°C	Resa w Δt 50°C	Resa Kcal Δt 60°C
10	360	394	428	685	744	809	879	897	975
12	430	473	514	822	893	971	1055	1076	1170
14	500	552	599	959	1042	1133	1231	1256	1365
16	570	630	685	1096	1190	1294	1406	1435	1560
18	640	709	770	1233	1339	1456	1582	1615	1755
20	710	788	856	1370	1488	1618	1758	1794	1950
22	780	867	942	1507	1637	1780	1934	1973	2145
24	850	946	1027	1644	1786	1942	2110	2153	2340
26	920	1024	1113	1781	1934	2103	2285	2332	2535
28	990	1103	1198	1918	2083	2265	2461	2512	2730
30	1060	1182	1284	2055	2232	2427	2637	2691	2925

N.B.: Su richiesta fornitura con dimensioni e rese diverse da quelle indicate.

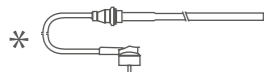

il modello è disponibile anche elettrico max 1200 Watt





MADE IN ITALY

Per i colori fuori standard consultare pag. 118-119.  
Su richiesta fornitura con dimensioni e rese diverse da quelle indicate.  
For out of standard colors consult page 118-119.  
On request supply sizes other than those specified and made.

A Astra S

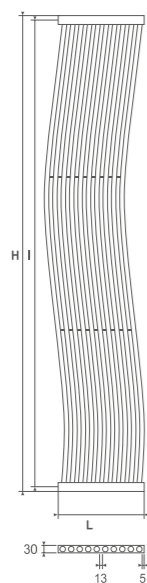

B Astra X

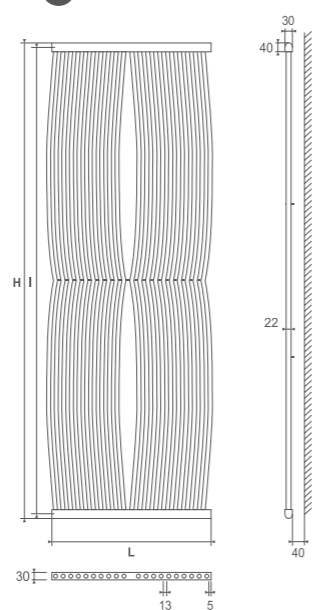

H		1500		1800		2000	
I		1465		1765		1965	
N. elem.	L	Resa w Δt 50°C	Resa Kcal Δt 60°C	Resa w Δt 50°C	Resa Kcal Δt 60°C	Resa w Δt 50°C	Resa Kcal Δt 60°C
10	360	685	744	809	879	897	975
12	430	822	893	971	1055	1076	1170
14	500	959	1042	1133	1231	1256	1365
16	570	1096	1190	1294	1406	1435	1560
18	640	1233	1339	1456	1582	1615	1755
20	710	1370	1488	1618	1758	1794	1950
22	780	1507	1637	1780	1934	1973	2145
24	850	1644	1786	1942	2110	2153	2340
26	920	1781	1934	2103	2285	2332	2535
28	990	1918	2083	2265	2461	2512	2730
30	1060	2055	2232	2427	2637	2691	2925

N.B.: Su richiesta fornitura con dimensioni e rese diverse da quelle indicate.

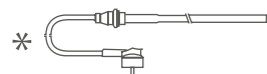

il modello è disponibile anche elettrico max 1200 Watt





Per i colori fuori standard consultare pag. 118-119.  
 Su richiesta fornitura con dimensioni e rese diverse da quelle indicate.  
 For out of standard colors consult page 118-119.  
 On request supply sizes other than those specified and made.

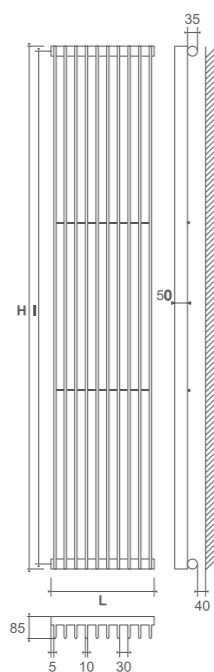

N. elem.	L	800		1500		1800		2000	
		Resa w Δt 50°C	Resa Kcal Δt 60°C	Resa w Δt 50°C	Resa Kcal Δt 60°C	Resa w Δt 50°C	Resa Kcal Δt 60°C	Resa w Δt 50°C	Resa Kcal Δt 60°C
6	220	284	309	512	556	610	662	674	733
8	300	379	412	683	742	813	883	899	977
10	380	474	515	854	927	1016	1104	1124	1221
12	460	569	618	1025	1112	1219	1325	1349	1465
14	540	664	721	1196	1298	1422	1546	1574	1709
16	620	758	824	1366	1483	1626	1766	1798	1954
18	700	853	927	1537	1669	1829	1987	2023	2198
20	780	948	1030	1708	1854	2032	2208	2248	2442
22	860	1043	1133	1879	2039	2235	2429	2473	2686
24	940	1138	1236	2050	2225	2438	2650	2698	2930
26	1020	1232	1339	2220	2410	2642	2870	2922	3175

N.B.: Su richiesta fornitura con dimensioni e rese diverse da quelle indicate.





tire

MADE IN ITALY

Per i colori fuori standard consultare pag. 118-119.  
 Su richiesta fornitura con dimensioni e rese diverse da quelle indicate.  
 For out of standard colors consult page 118-119.  
 On request supply sizes other than those specified and made.

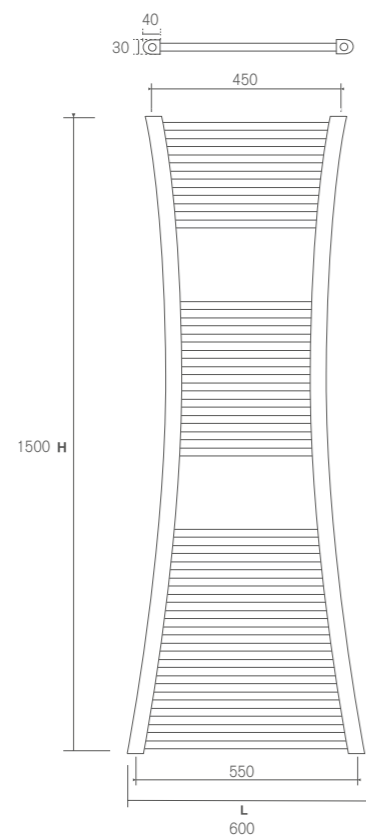

H	L	I	Resa w Δt 50°C	Resa Kcal Δt 60°C
1200	450/600	400/550	701	761
1500	450/600	400/550	877	952
1800	450/600	400/550	1090	1184

N.B.: Su richiesta fornitura con dimensioni e rese diverse da quelle indicate.

METALFORM  
design

NEW

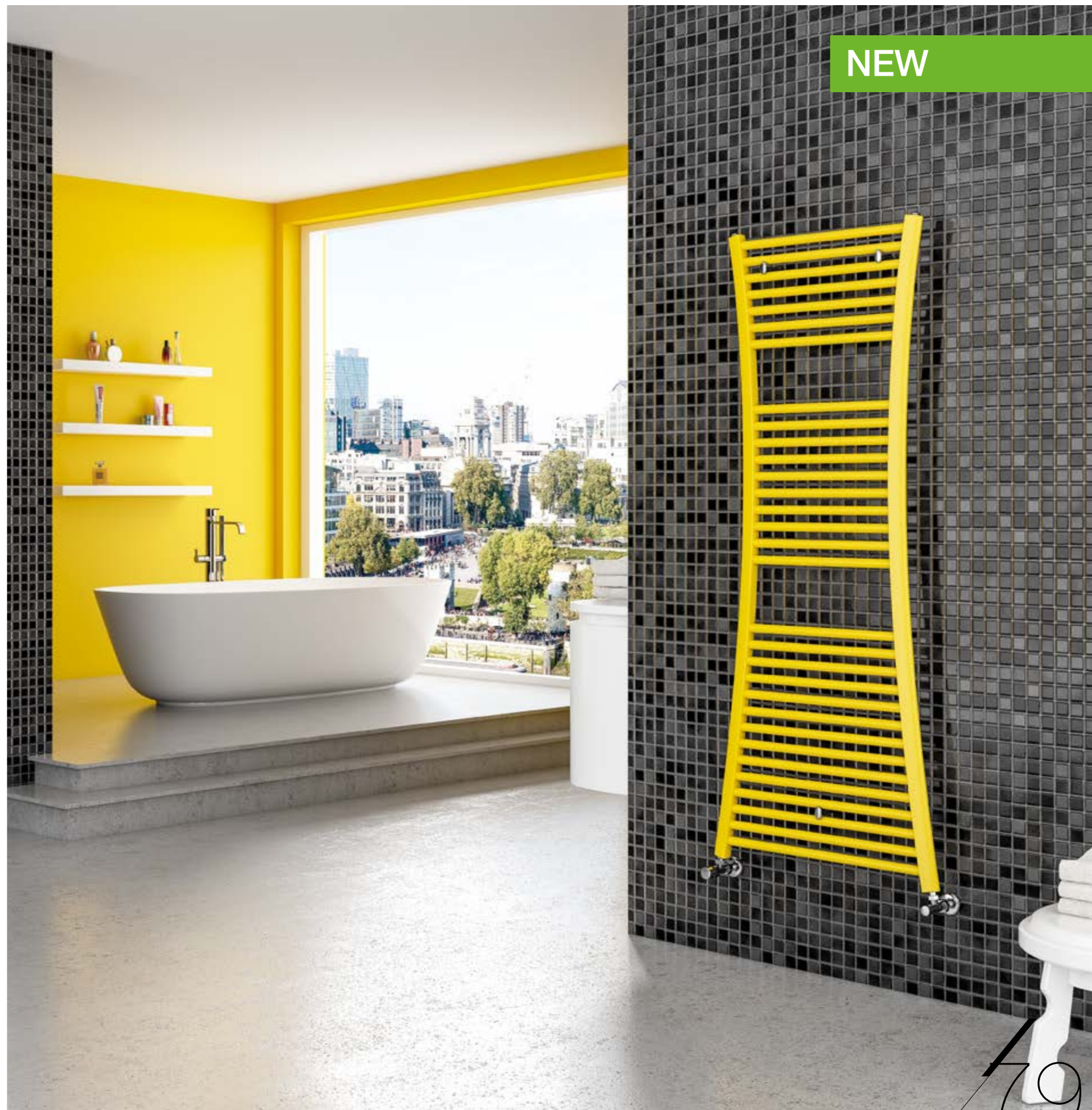



Per i colori fuori standard consultare pag. 118-119.  
 Su richiesta fornitura con dimensioni e rese diverse da quelle indicate.  
 For out of standard colors consult page 118-119.  
 On request supply sizes other than those specified and made.

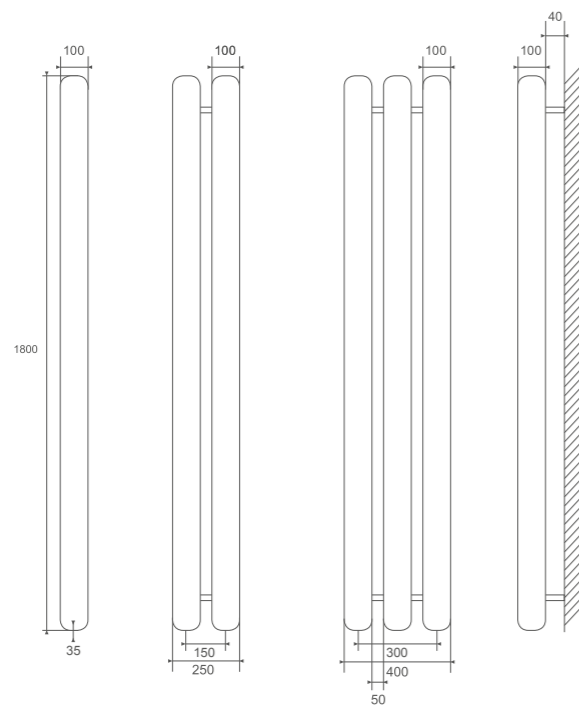

articolo	H	L	I	Ø tubo	Resa w Δt 50°C
LINEA 1	1800	100	35	100	270
LINEA 2	1800	250	150	100	540
LINEA 3	1800	400	300	100	810

N.B.: Su richiesta fornitura con dimensioni e rese diverse da quelle indicate.

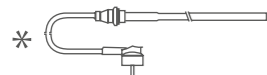

il modello è disponibile anche elettrico max 1200 Watt





Per i colori fuori standard consultare pag. 118-119.  
 Su richiesta fornitura con dimensioni e rese diverse da quelle indicate.  
 For out of standard colors consult page 118-119.  
 On request supply sizes other than those specified and made.

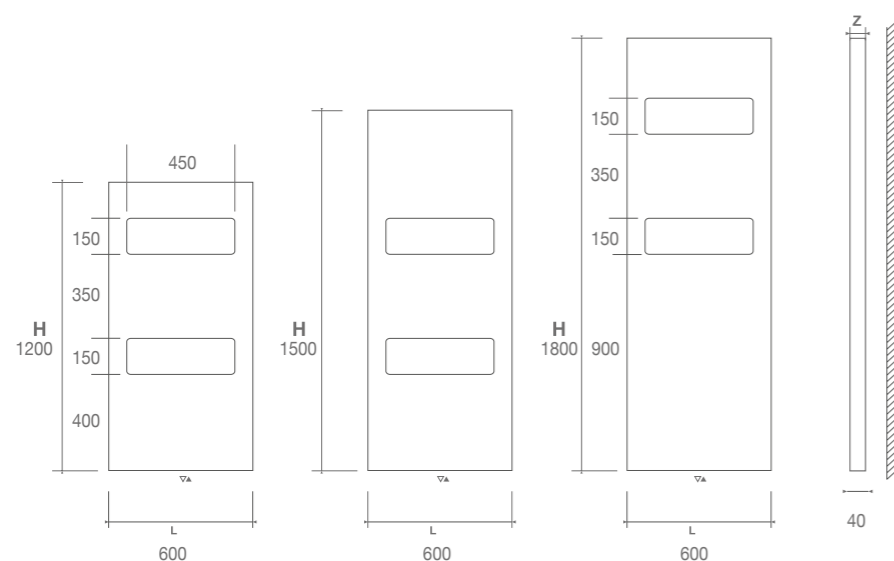

Cod. Art.	Dimensioni mm				Resa w Δt 50°C
	H	L	I	Z	
*TRMCVR12047	1200	600	50	40	776
*TRMCVR18047	1500	600	50	40	940
*TRMCVR18071	1800	600	50	40	1164

N.B.: Su richiesta fornitura con dimensioni e rese diverse da quelle indicate.

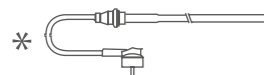

il modello è disponibile anche elettrico max  
1200 Watt



Supplemento per chromoterapy con  
retroilluminazione con variatore di luminosità  
telecomandato: € 1.400,00

NEW





# half circle

MADE IN ITALY

Per i colori fuori standard consultare pag. 118-119.  
 Su richiesta fornitura con dimensioni e rese diverse da quelle indicate.  
 For out of standard colors consult page 118-119.  
 On request supply sizes other than those specified and made.

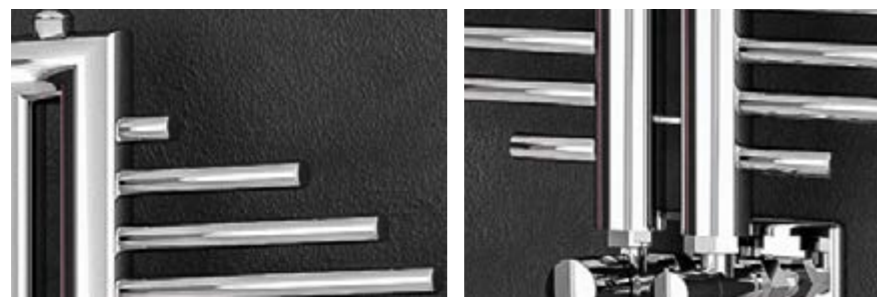
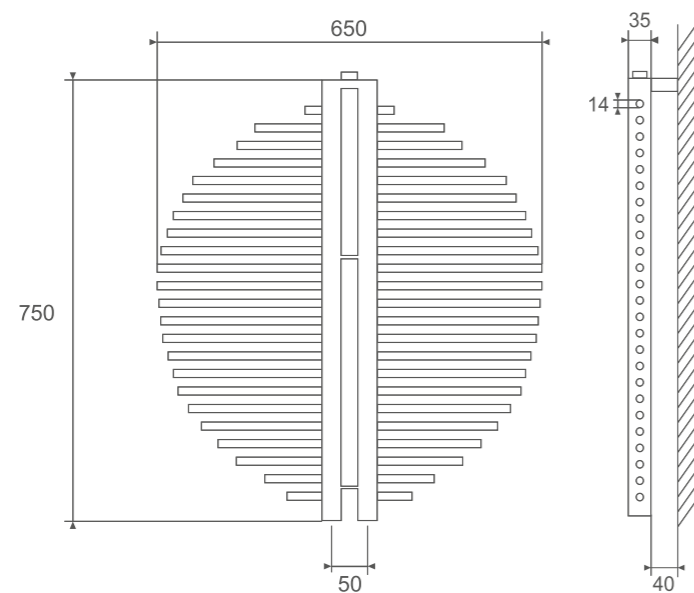

H	L	I	Resa w	Resa Kcal
750	650	50	332	360

N.B.: Su richiesta fornitura con dimensioni e rese diverse da quelle indicate.





eye

MADE IN ITALY

Per i colori fuori standard consultare pag. 118-119.  
Su richiesta fornitura con dimensioni e rese diverse da quelle indicate.  
For out of standard colors consult page 118-119.  
On request supply sizes other than those specified and made.

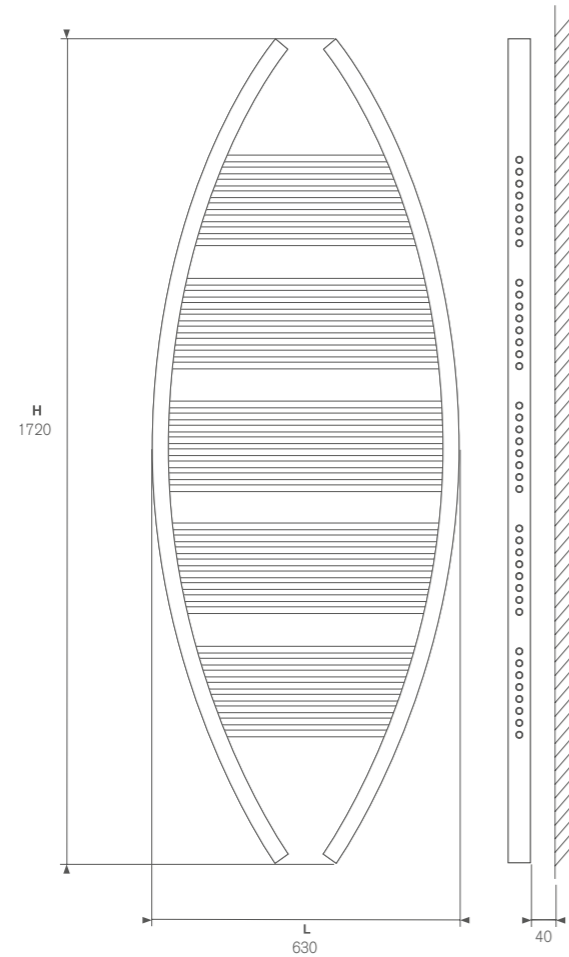

H	L	50	Resa w	Resa Kcal
1720	630		724	785

N.B.: Su richiesta fornitura con dimensioni e rese diverse da quelle indicate.

METALFORM  
design

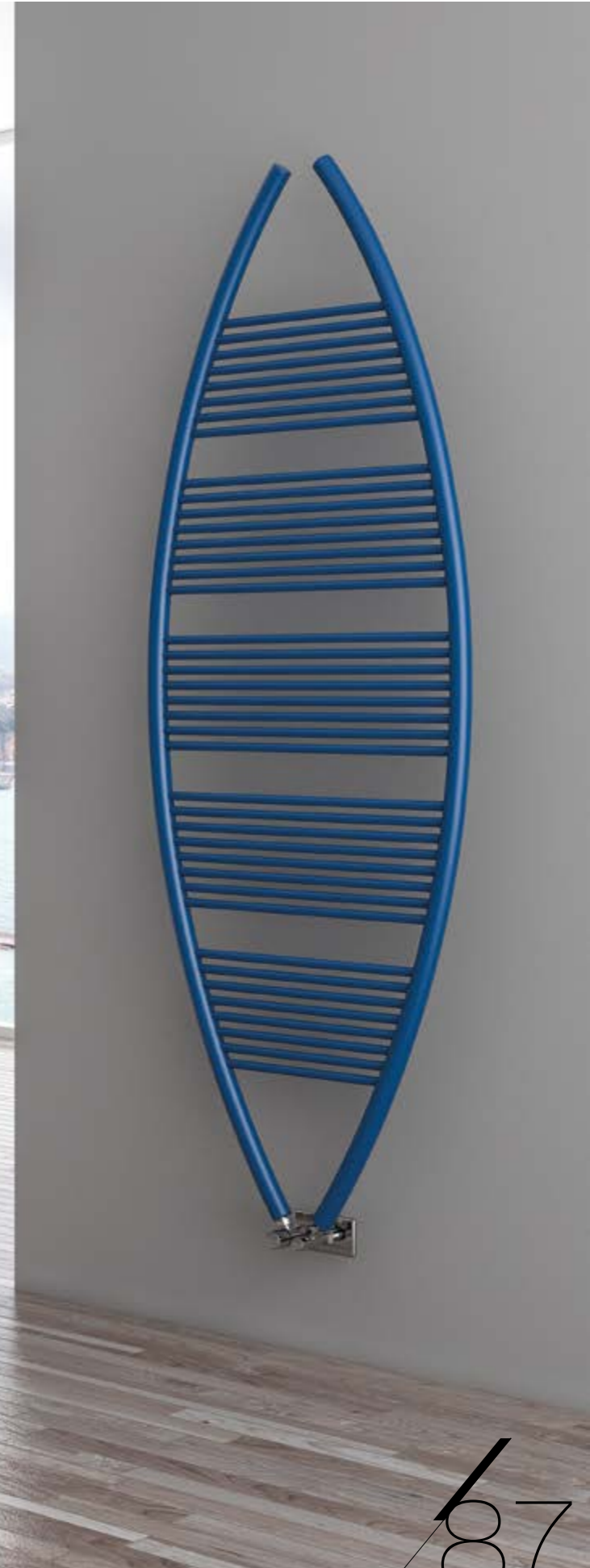



# border

MADE IN ITALY

Per i colori fuori standard consultare pag. 118-119.  
 Su richiesta fornitura con dimensioni e rese diverse da quelle indicate.  
 For out of standard colors consult page 118-119.  
 On request supply sizes other than those specified and made.

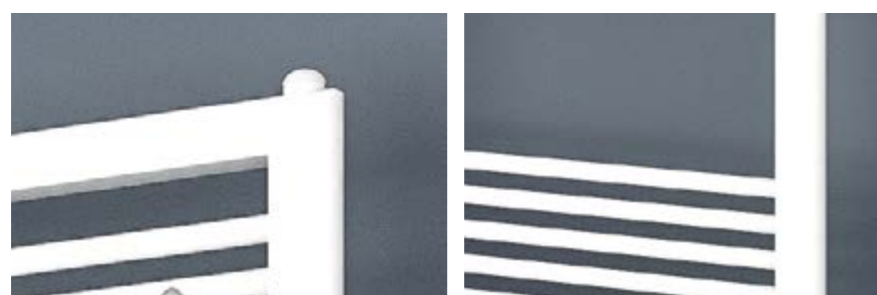
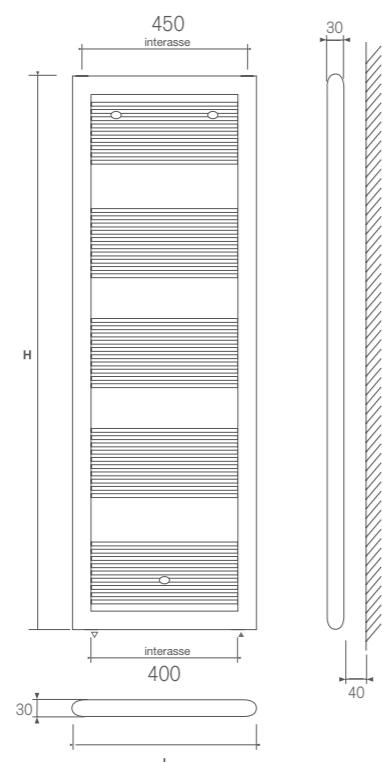

H	L	I	Resa w Δt 50°C	Resa Kcal Δt 60°C
800	510	400/450	419	455
1200	510	400/450	620	673
1500	510	400/450	780	840
1800	510	400/450	900	980

N.B.: Su richiesta fornitura con dimensioni e rese diverse da quelle indicate.

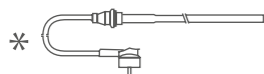

il modello è disponibile anche elettrico max 1200 Watt

NEW



Per i colori fuori standard consultare pag. 118-119.  
 Su richiesta fornitura con dimensioni e rese diverse da quelle indicate.  
 For out of standard colors consult page 118-119.  
 On request supply sizes other than those specified and made.

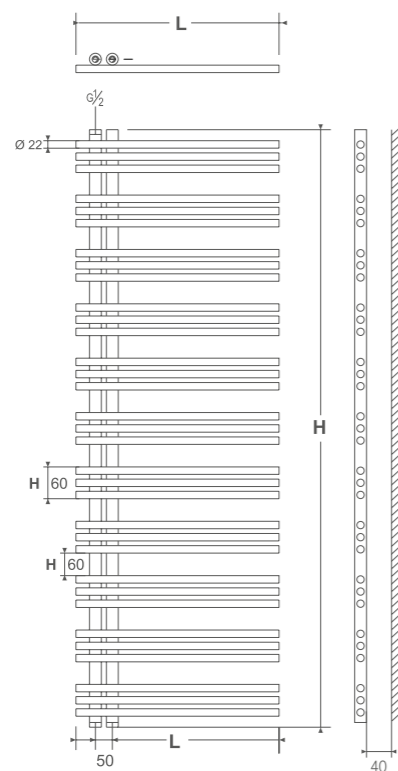

Art.	Dimensioni mm			Resa w Δt 50°C
	H	L	I	
*ASA6001100	1100	600	50	604
*ASA6001400	1400	600	50	775
*ASA6001800	1800	600	50	955





# quadra s 10

MADE IN ITALY

Per i colori fuori standard consultare pag. 118-119.  
 Su richiesta fornitura con dimensioni e rese diverse da quelle indicate.  
 For out of standard colors consult page 118-119.  
 On request supply sizes other than those specified and made.

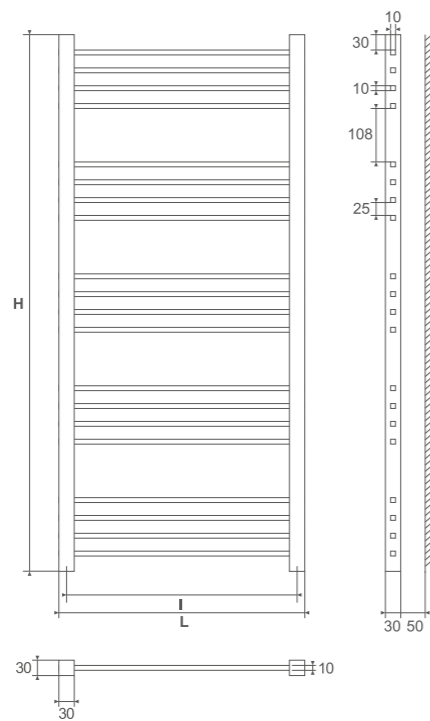

H	L	I	Capacità Lt.	Bianco		cromato	
				Resa w $\Delta t$ 50°C	Resa Kcal $\Delta t$ 60°C	Resa w $\Delta t$ 50°C	Resa Kcal $\Delta t$ 60°C
1060	480	450	2,1	430	543	345	424
1060	530	500	2,3	437	552	350	441
1500	480	450	2,8	563	712	450	570
1500	530	500	3	572	722	460	580

N.B.: Su richiesta fornitura con dimensioni e rese diverse da quelle indicate.

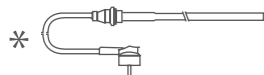

\* il modello è disponibile anche elettrico max 1200 Watt



# quadra s 25

MADE IN ITALY

Per i colori fuori standard consultare pag. 118-119.  
 Su richiesta fornitura con dimensioni e rese diverse da quelle indicate.  
 For out of standard colors consult page 118-119.  
 On request supply sizes other than those specified and made.

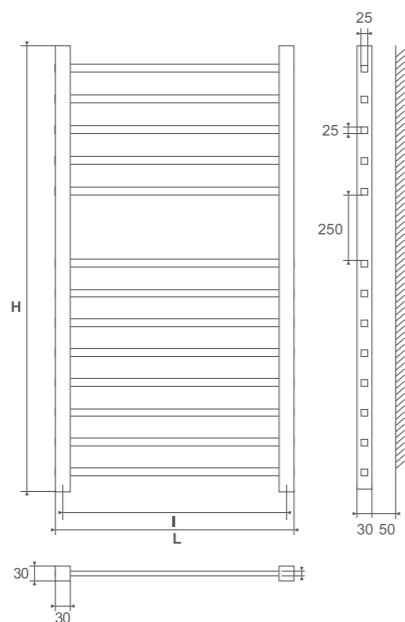

	Cod. Art.	H	L	I	Capacità Lt.	Rese w Δt 50°C	Rese Kcal Δt 60°C
<b>Bianco</b>	QDRS25-080 5535199509010	800	500	470	3,3	260	280
	QDRS25-120509010	1200	500	470	5,1	395	427
	QDRS25-120609010	1200	600	570	5,6	415	448
	QDRS25-150509010	1500	500	470	5,4	500	540
	QDRS25-150609010	1500	600	570	6,9	525	567
	QDRS25-180509010	1800	500	470	7,7	575	620
	QDRS25-180609010	1800	600	570	8,1	600	648

	Cod. Art.	H	L	I	Capacità Lt.	Rese w Δt 50°C	Rese Kcal Δt 60°C
<b>CROMO</b>	QDRS25-080 553519950CROM	800	500	470	3,3	160	173
	QDRS25-12050CROM	1200	500	470	5,1	240	259
	QDRS25-12060CROM	1200	600	570	5,6	250	270
	QDRS25-15050CROM	1500	500	470	5,4	300	324
	QDRS25-15060CROM	1500	600	570	6,9	315	340
	QDRS25-18050CROM	1800	500	470	7,7	345	372
	QDRS25-18060CROM	1800	600	570	8,1	360	388

N.B.: Su richiesta fornitura con dimensioni e rese diverse da quelle indicate.

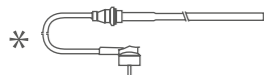

\* il modello è disponibile anche elettrico max 1200 Watt





Per i colori fuori standard consultare pag. 118-119.  
 Su richiesta fornitura con dimensioni e rese diverse da quelle indicate.  
 For out of standard colors consult page 118-119.  
 On request supply sizes other than those specified and made.

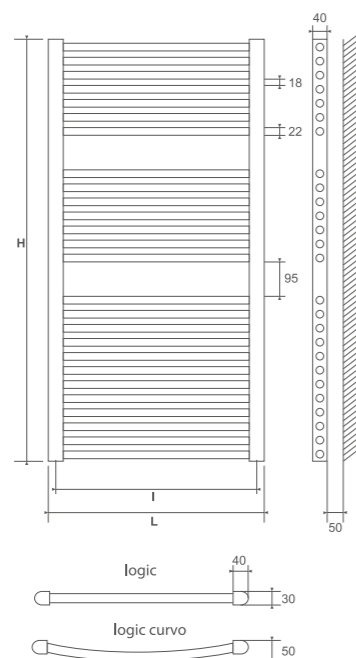

H	L	I	Capacità Lt.	Resa w Δt 50°C	Resa Kcal Δt 60°C
800	450	400	3,50	404	439
800	500	450	3,70	497	474
800	550	500	4,00	468	508
800	600	550	4,30	499	542
1200	450	400	5,30	631	685
1200	500	450	5,70	680	738
1200	550	500	6,10	727	789
1200	600	550	6,50	776	842
1500	450	400	6,50	752	816
1500	500	450	7,00	846	918
1500	550	500	7,50	877	952
1500	600	550	8,00	940	1020
1800	450	400	7,70	945	1026
1800	500	450	8,40	1018	1105
1800	550	500	9,10	1091	1184
1800	600	550	9,80	1164	1264

N.B.: Su richiesta fornitura con dimensioni e rese diverse da quelle indicate.

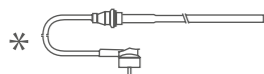

il modello è disponibile anche elettrico max 1200 Watt



# logic cromo 19

MADE IN ITALY

Per i colori fuori standard consultare pag. 118-119.  
 Su richiesta fornitura con dimensioni e rese diverse da quelle indicate.  
 For out of standard colors consult page 118-119.  
 On request supply sizes other than those specified and made.

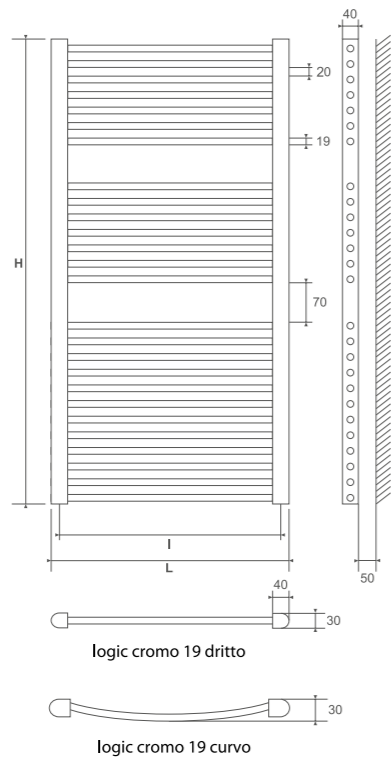

H	L	I	Resa w $\Delta t$ 50°C	Resa Kcal $\Delta t$ 60°C
800	450	400	215	236
800	500	450	241	265
800	550	500	245	270
800	600	550	280	308
1200	450	400	325	357
1200	500	450	370	407
1200	550	500	379	417
1200	600	550	435	478
1500	450	400	414	455
1500	500	450	466	512
1500	550	500	471	518
1500	600	550	551	606
1800	450	400	491	540
1800	500	450	694	763
1800	550	500	719	791
1800	600	550	870	957

N.B.: Su richiesta fornitura con dimensioni e rese diverse da quelle indicate.

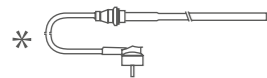

\* il modello è disponibile anche elettrico max 1200 Watt





# radius

MADE IN ITALY

Per i colori fuori standard consultare pag. 118-119.  
 Su richiesta fornitura con dimensioni e rese diverse da quelle indicate.  
 For out of standard colors consult page 118-119.  
 On request supply sizes other than those specified and made.

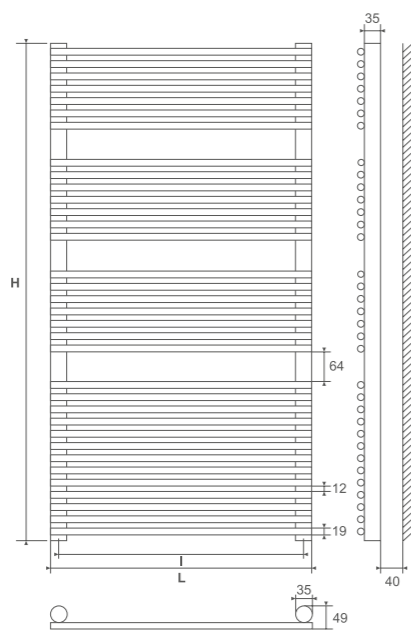

H	L	I	Bianco	Cromo
			Resa w Δt 50°C	Resa w Δt 50°C
800	500	450	500	350
1200	500	450	700	500
1500	500	450	900	600
1800	500	450	1050	700

N.B.: Su richiesta fornitura con dimensioni e rese diverse da quelle indicate.

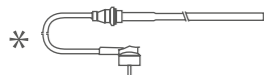

il modello è disponibile anche elettrico max 1200 Watt



# radius doppio

MADE IN ITALY

Per i colori fuori standard consultare pag. 118-119.

Su richiesta fornitura con dimensioni e rese diverse da quelle indicate.

For out of standard colors consult page 118-119.

On request supply sizes other than those specified and made.

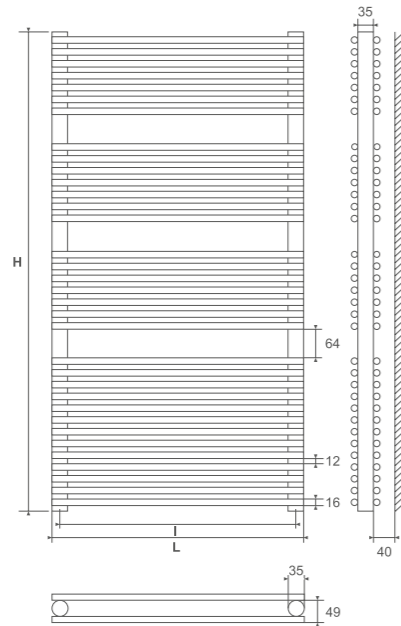

H	L	I	Bianco
			Resa w Δt 50°C
720	490	455	539
720	540	505	595
720	590	555	637
720	740	705	776
720	990	955	1012
1100	490	455	786
1100	540	505	866
1100	590	555	924
1100	740	705	1130
1100	990	955	1470
1480	490	455	993
1480	540	505	1095
1480	590	555	1166
1480	740	705	1425
1480	990	955	1835
1850	490	455	1222
1850	540	505	1347
1850	590	555	1437
1850	740	705	1755
1850	990	955	2284

N.B.: il modello RADIUS DOPPIO non è disponibile nella versione cromata.

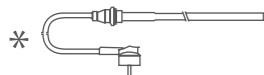

il modello è disponibile anche elettrico max 1200 Watt





MADE IN ITALY

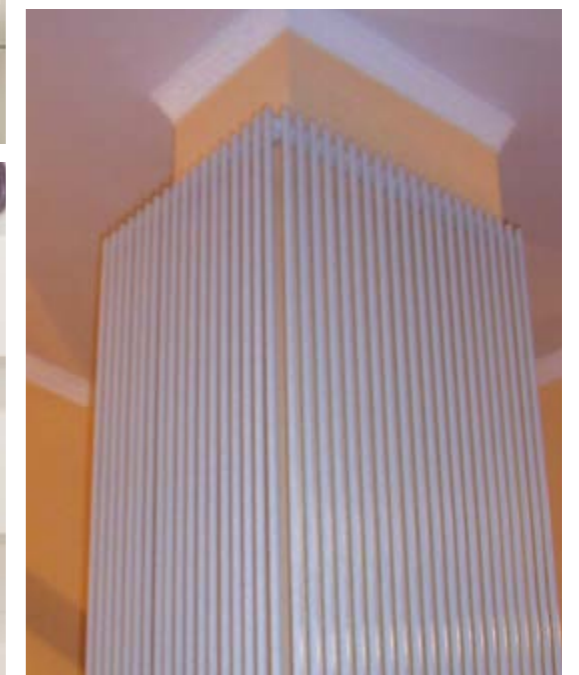
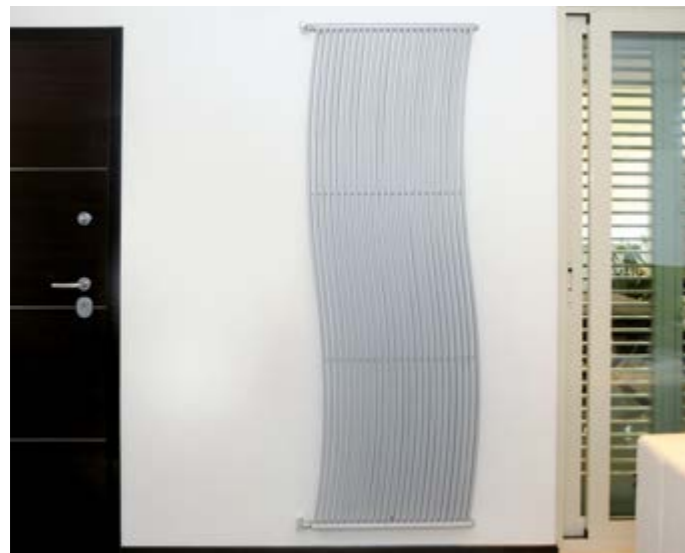

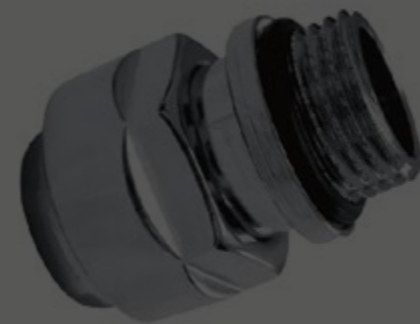

METALFORM  
design

## indice accessori

---

catalogo\_listino tecnico  
**01.2016**

listini	
listino accessori	108   112
listino attacchi	113   115
accessori attacchi	116
Listino essenze linea wood	117
listino gamma colori	118   119
<b>condizioni di vendita</b>	120
<b>anagrafica clienti</b>	121
<b>corner espositivi</b>	122





### A00110

Coppia valvola e detentore "Quadra" completo di raccordo o-ring di cui bisogna specificare il Ø (disponibile anche per multistrato).  
A pair of valve and valve "Quadra" complete of connection o-ring which is necessary specify the Ø.  
Misure raccordo o-ring: Ø 10-12-14-16  
Measure of connection o-ring: Ø 10-12-14-16  
Bianco - white  
Cromato - chromium plated



### A00111 (V/D)

Coppia valvola e detentore "Tonda" completo di raccordo o-ring di cui bisogna specificare il Ø (disponibile anche per multistrato).  
Disponibile termostattizzabile.  
A pair of valve and valve "Tonda" complete of connection o-ring which is necessary specify the Ø.  
Misure raccordo o-ring: Ø 10-12-14-16  
Measure of connection o-ring: Ø 10-12-14-16  
Bianco - white  
Cromato - chromium plated



### A00112 (V/D)

Coppia valvola e detentore "Angolo" completo di raccordo o-ring di cui bisogna specificare il Ø (disponibile anche per multistrato).  
A pair of valve and valve "Angolo" complete of connection o-ring which is necessary specify the Ø.  
Misure raccordo o-ring: Ø 10-12-14-16  
Measure of connection o-ring: Ø 10-12-14-16  
Bianco - white  
Cromato - chromium plated



### A00108

Valvola monotubo termostattizzabile e detentore incorporato (mandata dx o sx).  
Interasse 4  
Thermostatizable monotube angle radiator valve and lockshield, mm 40 (right or left). Wheelbase 4  
Bianco - white  
Cromato - chromium plated



### A00118

Valvola monotubo termostattizzabile e detentore incorporato (mandata dx o sx).  
Interasse 4  
Monotube radiator valve of 1/2 (left). Wheelbase 4  
Bianco - white  
Cromato - chromium plated



### A00105

Testa termostatica  
Thermostatic hand  
Bianco - white  
Cromato - chromium plated



### A00190 Ø50

Kit copritubo universale "multistrato" (2 pezzi). Ø 18 x L 70 x Ø 10-12-14-16  
Universal kit tube cover "multistrato" (2 pieces). Ø 18 x L 70 x Ø 10-12-14-16  
Bianco - white  
Cromato - chromium plated



### A00190 QUADRA

Kit copritubo universale quadrato "multistrato" (2 pezzi). L40 x L40 x Ø 10-12-14-16  
Universal kit tube cover "multistrato" (2 pieces). L40 x L40 x Ø 10-12-14-16  
Bianco - white  
Cromato - chromium plated



### A00191

Kit copritubo universale "Quadra" doppio (1 pezzo). Ø 18 x L 70 x Ø 10-12-14-16  
Universal kit tube cover double "Quadra" (1 piece). Ø 18 x L 70 x Ø 10-12-14-16  
Bianco - white  
Cromato - chromium plated



### A00199

Rosetta copritubo  
Tube cover  
Bianco - white  
Cromato - chromium plated  
N.b.: In fase di ordine indicare il diametro



### A00104

Cordolo da 1/2" o 3/8"  
Tailpiece of 1/2" or 3/8"



### A0005

Valvolino girevole speciale  
Particular small valve



### A0481 (2 pz.)

Raccordo per tubo rame  
Ø10, Ø12, Ø14, Ø16  
Copper tube connection  
Ø10, Ø12, Ø14, Ø16



### A0483 (2 pz.)

Raccordo per tubo multistrato Ø16x2, Ø14x2  
Multilayer tube connection Ø16x2, Ø14x2



### A004T

Raccordo a "T" specifico per il funzionamento con l'inserimento della resistenza elettrica  
"T" connection necessary for working happen with electric heater  
Bianco- white  
Cromato - chromium plated



### A004G Glicole: acqua glicolata

Water with glycolic alcohol

Al litro - one liter

\*N.B.  
i radiatori che funzioneranno solo elettricamente non vanno riempiti di acqua glicolata sino all'orlo ma va lasciato 1 cm di vuoto.  
Don't fill the radiator that electrically work, but leave about 1 centimeter of empty space.



### A004400\* L41

Resistenza elettrica 400W  
Electric heater 400W

### A004600\* L55

Resistenza elettrica 600W  
Electric heater 600W

### A004900\* L71

Resistenza elettrica 900W  
Electric heater 900W

### A0041200\* L91

Resistenza elettrica 1200W  
Electric heater 1200W



### A0069010 "Quadra" (3 PZ.) couple

Supporto per termoarredi e scaldasalviette  
For "Quadra" serviette warmer support  
Bianco- white

### A0069010 "Quadra" (3 PZ.) couple

Supporto per termoarredi e scaldasalviette  
For "Quadra" serviette warmer support  
Cromato - chromium plated

### A0069010 "L" (3 PZ.)

Supporto per termoarredi e scaldasalviette  
For "L" serviette warmer support  
Bianco- white

### A0069010 "Q" (3 PZ.)

Supporto per termoarredi e scaldasalviette  
For "Quadra" serviette warmer support  
Cromato - chromium plated



### Resistenza elettrica con termostato regolabile 600W

Electric heater with temperature control 600W

A0056009010\*  
Bianco- white

A005600CROM\*  
Cromato - chromium plated

### Resistenza elettrica con termostato regolabile 900W

Electric heater with temperature control 900W

A0059009010\*  
Bianco- white

A005900CROM\*  
Cromato - chromium plated



### A007 Logic (coppia) couple

Mensola di fissaggio a bandiera (reversibili)  
Shelf of fixing to flag (reversible)  
N.B. Per l'utilizzo della mensola considerare distanza dalla parete al tubo rame di 70 mm  
N.B. for the utilization of shelf to consider the distance from the wall to copper pipe 70 millimeters.



### A008 (coppia) couple

Mensole fisse di fissaggio a bandiera (da specificare de dx o sx)  
Fixed shelf of fixing flag (to indicate if right or left)  
Prezzi Bianco e Cromo  
Fissa i multipli di 30 mm  
Fixed distance from the wall 30 mm



## A010 Fissaggio per pavimento – soffitto

Fixing for floor-ceiling  
Il kit comprende n. 2 piedini di sostegno (cod. A009) e n 2 aste (misure a richiesta max 100 cm) ed accessori per il montaggio  
It includes two supports (cod. A009) and two poles (measure to greatest request of centimetres 100) and the fitting for the assembly.



### A002 Portasciugamani Fittine to hang towel

Bianco		CROMO	
L	Prezzi €	L	Prezzi €
400	42,00	400	50,00
500	44,00	500	54,00
600	46,00	600	56,00



### A003 Appendiabiti (coppia) couple

Bianco – white  
Cromato – chromium plated



SUPERFICIE IN  
VERO SPECCHIO

### A019 (fig. 1) Specchio "Omino" Mirror with man's shape

### A022 (fig. 2) Specchio rettangolare cm 24x180 – 24 x 200 Rectangular mirror 24x180 – 24x 200 centimetres

## Attacchi di serie The connection of series

Sfilato Ø 1/2" – air valve  
Entrata Ø 1/2" – entrance

Uscita Ø 1/2" – outlet  
Destra – right  
Sinistra – left

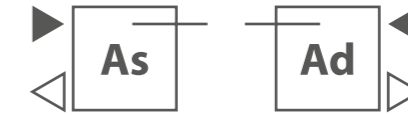

## Attacchi a richiesta con supplemento Extra connections (on request) with supplemento

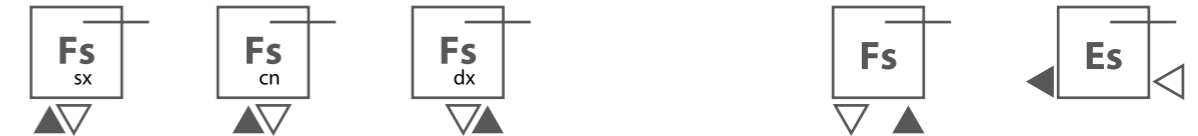

mandata  
obbligatoria  
a sinistra

mandata  
obbligatoria  
a destra

### A017

Nel caso di allacciamenti sottostanti  $F_s = 3/8$  " gas, per calcolare l'interasse va considerata la larghezza e sottratti 60 mm

In the case of connection submitting,  $F_s = 3/8$  " gas, to calculate the wheelbase it is necessary to consider the width and deduct 60 mm

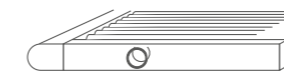

### A018

Nel caso di allacciamenti sottostanti  $E_s = 1/2$  " gas, utilizzando una valvola d'arredo, per calcolare l'interasse va considerata la larghezza aggiungendo 90 mm

In the case of connection submitting,  $E_s = 1/2$  " gas, using a valve of furnishing, to calculate the wheelbase it is necessary to consider the width adding 90 mm

### A011

Interassi con misure a richiesta (su radiatore standard)  
The wheelbase with measure on request (standard radiator)

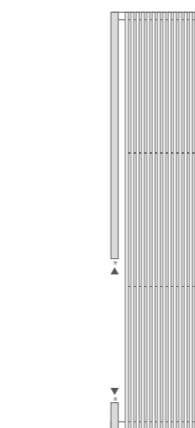

pavimento

### A000

#### Interasse speciale laterale su termoarredi sistema sostitutivo

Indicare altezza dal primo tubo al pavimento, l'interasse e il lato.

A012

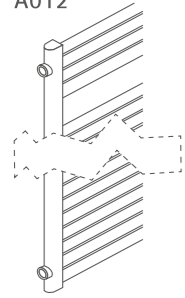

**A012**

Attacchi laterali sul montante (su radiatore standard)  
 Side connections on upright (standard radiator)

**Attacchi monotubo**

Monotube radiator connections

A014/A015

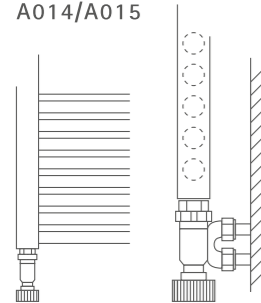

**A014 a corredo su richiesta** – on request

Posizione inferiore con inserimento della valvola diametro 1/2 " sul montante  
 Lower position with insertion of valve diameter 1/2 " on standard upright

**A015**

Posizione inferiore con inserimento della valvola diametro 3/4 " o 1" sul montante standard (specificare se dx o sx)  
 Lower position with insertion of valve diameter 3/4 " or 1" on standard upright (to specify if right or left)

A016/A

A016/B

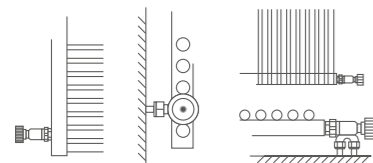

**A016 /A fig 4/A**

(solo per mod. Logic) attacco con inserimento laterale della valvola sul montante standard (specificare se dx o sx ed il diametro della valvola e della sonda)  
 (only for mod. Logic) side insetion of valve on standard upright (to specify if right or left and the diameter of valve and the feeler)

**A016 / B fig. 4/B**

(solo per Termoarredi) attacco con inserimento della valvola sul collettore (specificare se dx o sx ed il diametro della valvola e della sonda)  
 (only for mod. Thermo-furnishing) Insetion of valve on upright (to specify if right or left and the diameter of valve and the feeler)



**A013 a preventivo** – with estimate expense

Versione con misure a richiesta (disegno tecnico fornito dal cliente)  
 Model with measure on request (with estimate expense)

**Esempio di montaggio orizzontale (su richiesta)**

Example of horizontal fixing (on request)

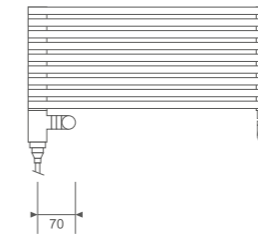
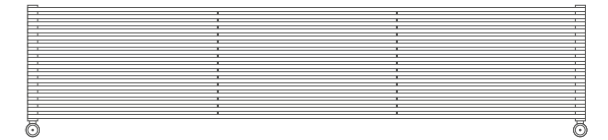

Per il montaggio del radiatore misto all'interasse sottrarre 70 mm  
 For the assembling of radiator's combination it is necessary subtract 70 millimeters from he wheelbase

**Attacchi a bandiera**



A008

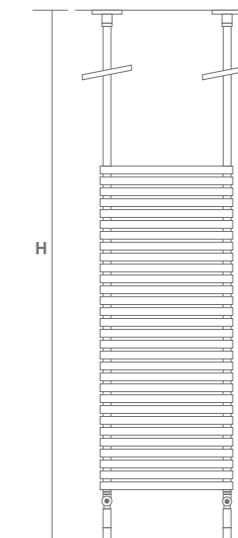

A010

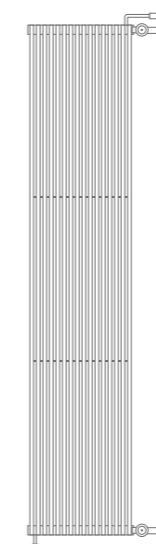

**Attacco standard**  
 Standard collection

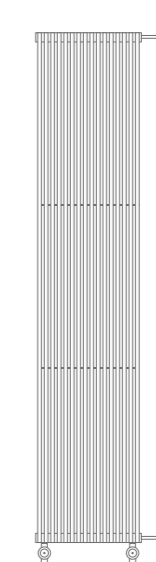

A017



	A000	A00108	A002	A003	A004600 - A004900 A004600 - A004900 A0041200	A007	A008	A010	A011-A012	A013	A014-A015	A016	A017	A018	Cromatura
Termo (wood, rfx, motif, note, comb, loop, snake, cover, flower, puzzle, balls, tube, street,)	●				●		●	●	●	●				●	
Ombre	●						●	●	●	●				●	
steel					●					●	●				●
cactus					●					●	●				
tubone	●				●		●	●	●	●	●	●		●	
luxor rfx	●		●	●			●	●	●	●		●		●	
Luxor	●		●	●			●	●	●	●		●		●	
Luxor doppio	●						●	●	●	●		●		●	
Luxor doppio rfx	●						●	●	●	●		●		●	
luxor pm - ondalux	●		●	●			●	●	●	●		●		●	
Quadra T 15	●		●	●			●	●	●	●		●		●	●
Quadra T doppio	●						●	●	●	●		●		●	
quadrone					●		●	●	●	●	●	●		●	
cili					●					●	●			●	●
easy			●	●					●	●					
Ultra - ultra s	●		●	●			●	●	●	●		●		●	●
Ultra rfx - ultra rfx s	●		●	●			●	●	●	●		●		●	●
Linea doppio - linea doppio s	●						●	●	●	●		●		●	
Linea doppio rfx - linea doppio rfx s	●						●	●	●	●		●		●	
astra	●		●	●	●		●	●	●	●		●		●	●
astra s - astra x	●		●	●	●		●	●	●	●		●		●	●
roxy	●						●	●	●	●		●		●	
tire			●	●					●	●					
line					●		●	●	●	●	●	●		●	●
oslo	●				●		●	●	●	●	●	●		●	
half circle			●	●					●	●					●
eye			●	●					●	●					
border			●	●	●	●	●	●	●	●	●	●		●	
asia			●	●					●	●					
Quadra s 10			●	●	●		●	●	●	●	●			●	●
Quadra s 25					●				●	●					●
logic			●	●	●	●	●	●	●	●	●	●		●	●
logic cromo 19			●	●	●	●	●		●	●	●			●	●
radius			●	●	●		●	●	●	●	●			●	●
radius doppio					●		●	●	●	●	●			●	

ESSENZEWOOD

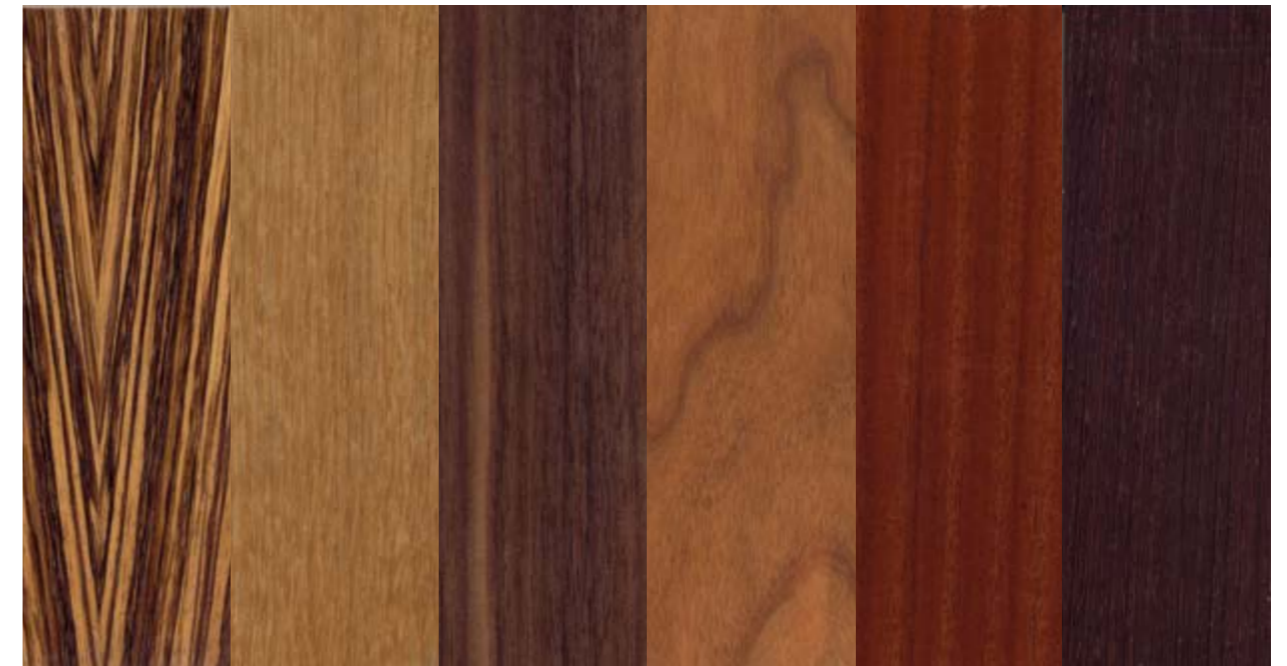

Zebrano    Rovere naturale    Noce medio    Ciliegio    Mogano naturale    Wengè

N.B.: la cromia dei campioni colore riportati in tabella è indicativa per questioni di carattere tipografico, far riferimento alle mazzette ufficiali.

### RALBASIC

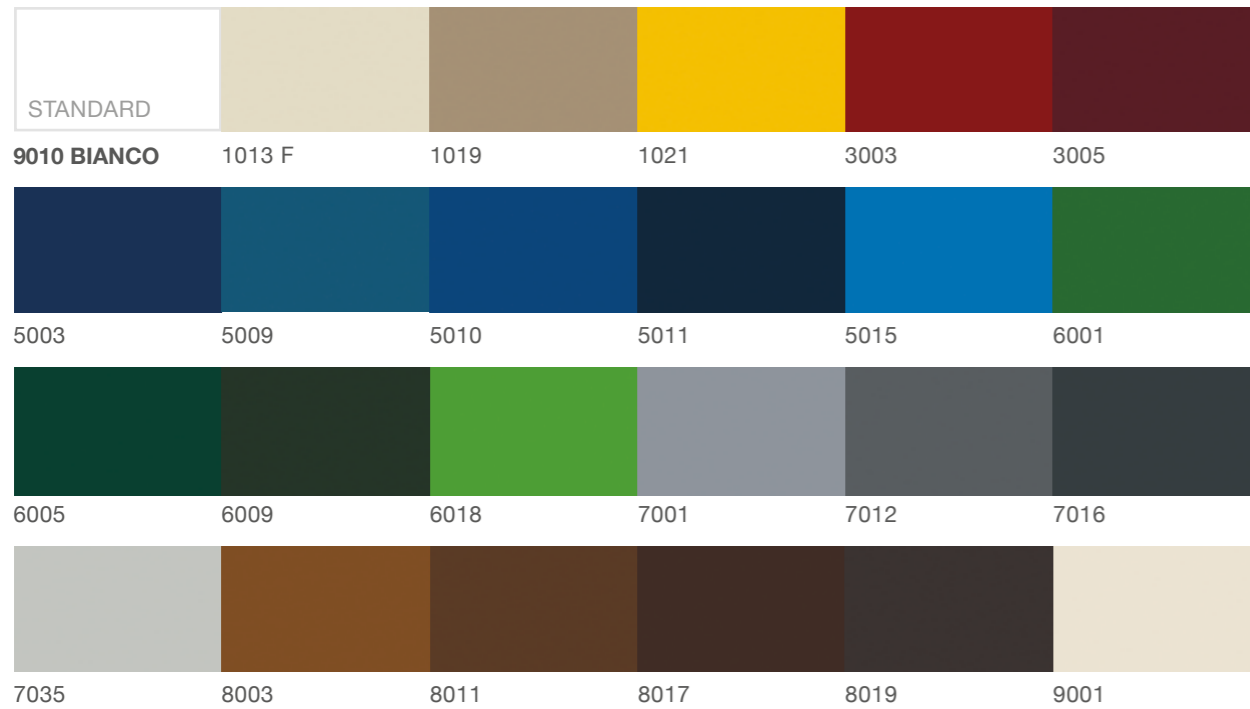

### RALOPACHI

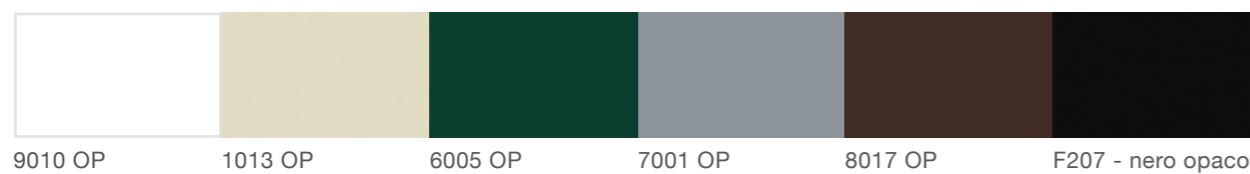

### RALRUVIDI



### PUNTINATILISCI

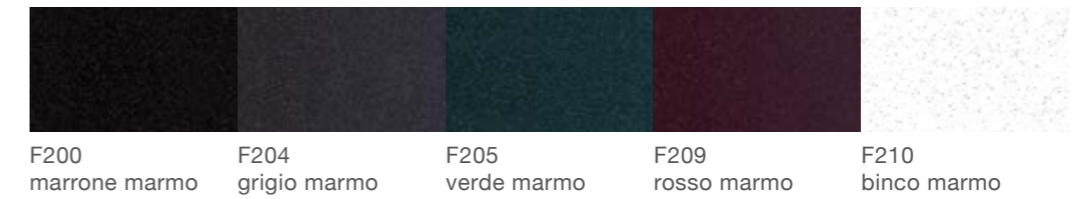

### PUNTINATIRUVIDI

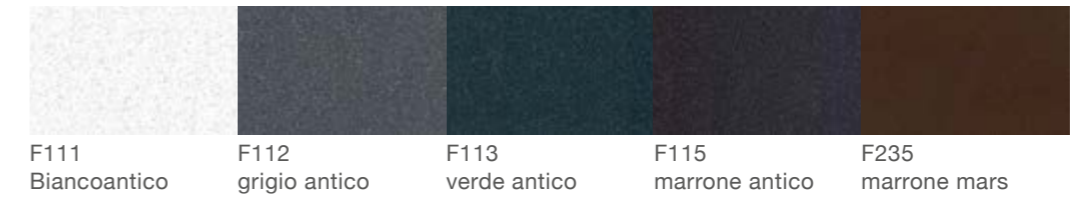

### RALBUGNATI

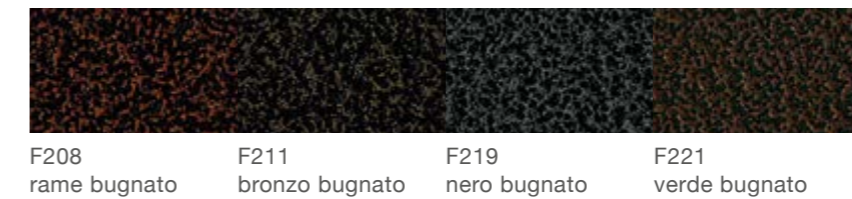

### METALLIZZATIESPECIALI



### CROMATURA

N.B.: la cromia dei campioni colore riportati in tabella è indicativa per questioni di carattere tipografico, far riferimento alle mazzette ufficiali.



# condizioni generali di vendita

# METALFORM design

# METALFORM design

L'accettazione degli organi, l'esecuzione e la consegna dei radiatori, sono subordinate alle seguenti nostre condizioni generali di vendita:

Ordini: gli ordini devono pervenire in forma chiara e leggibile e sono comunque subordinati all'approvazione della Metalform Design Srls. Gli ordini telefonici vanno seguiti da conferma via fax o via e-mail.

Modifiche di ordini: eventuali modifiche agli ordini devono essere comunicate, in forma scritta, entro due gironi dal ricevimento dello stesso. Le modifiche possibili relative a merce già immessa nel ciclo produttivo comportano una maggiorazione del 30% del costo. Modifiche richieste non possibili comportano la regolare fatturazione della merce.

Annullamento di ordini: eventuali annullamenti sono subordinati alla nostra approvazione e comunque devono pervenire in forma scritta e motivata, entro cinque giorni dal ricevimento dell'ordine.

Prezzi: i prezzi di listino si intendono iva esclusa franco nostra sede, non sono impegnativi e possono essere variati in qualsiasi momento, anche senza preavviso.

Modalità e termini di pagamento: le condizioni commerciali di vendita sono quelle concordate e confermate sull'ordine. Per ritardati pagamenti saranno addebitate spese bancarie e interessi.

Reclami e resi: la merce viaggia a rischio e pericolo del destinatario che è responsabile dello scarico della stessa. Reclami per danni causati dal trasporto o merci mancanti devono essere evidenziati subito a ricevimento firmando con riserva il DDT e informando Metalform Design Srls per scritto entro due giorni dal ricevimento. Reclami per difetti di fabbricazione devono essere tempestivamente segnalati al momento dell'evidenza del danno e comunque non oltre 10 giorni dal ricevimento della merce. Senza il consenso scritto della Metalform Design Srls non sarà accettato nessun reso.

Imballo: l'imballaggio standard è compreso nel Prezzo di vendita salvo eventuali imballi speciali che saranno addebitati a parte.

Termini di consegna: il termine utile di consegna è quello previsto indicativamente nella nostra conferma d'ordine e si riferisce al momento in cui la merce è pronta per la spedizione. Qualora i termini di consegna non possono essere rispettati nessun indennizzo può essere richiesto. Garanzia: i radiatori Metalform Design Srls subiscono una prova di pressione a 10 bar e sono garantiti per un periodo di 5 anni dalla consegna, alle seguenti condizioni:

- Immagazzinamento idoneo;
- Installazione effettuato secondo le norme e da personale qualificato
- Alimentazione con acqua non corrosiva
- Pressione massima di esercizio 8 bar
- Non utilizzo di canapa sui collegamenti provvisti di guarnizioni o-ring
- Pulizia con detergenti non aggressivi

N. B. i radiatori Metalform Design Srls non sono garantiti se collegati ad impianti con vaso d'espansione aperto. Per qualsiasi controversia è competente il Foro di Bari. Tutte le misure sono espresse in mm. Il presente annulla il precedente. La Metalform Design Srls si riserva il diritto di apportare eventuali variazioni ai modelli e alle misure senza alcun preavviso.

## General conditions of sale

The acceptance of orders, the execution and delivery of the radiators are subordinated to the following conditions

Orders: the orders must receive in clear and legible writing and they are subordinated to the approval of Metalform Design Srls. Telephone orders must continue in fax or e-mail confirmation.

Alteration of orders: eventual alterations of orders must be communicate in writing, within two days from the receipt of the same. The possible alterations of goods already introduced in the productive cycle involve an increase of 30% of cost. Impossible alterations of goods involve a regular invoice of goods.

Cancellation of orders: eventual cancellations of orders are subordinated to our approval and whatever must continue in writing, with are real cause, within five days on receipt of the order.

Prices: the pricelist is free-port our office; it is not binding and can be varied in any moment without notice.

Term and Limits of payment: commercial conditions of sale are confirmed and agreed on the order. For the defaulter banking charge and interest will be debited.

Complaints and given back: the goods travel at risk and danger of the consignee, who is responsible of unloading.

The complaints for damages caused of transport or the lack of goods must be put in evidence on receipt of goods, signing the consignment note and informing with letter Metalform Design Srls within two day on receipt. The complains for mechanical defect must be put in evidence within ten days on receipt. The given back of goods will accept only with written approval of Metalform Design Srls.

Packing: standard paking is included in sale's price, except special packing that is extra.

Delivery: the last time for delivering is write in our order confirmation and it is reported the moment in which the goods are ready for forwarding. For delay of delivery, Metalform Design Srls will not be paid any compensation for damages.

Warranty: the radiators undergo a test of pressure to 10 bar. The validity of warranty is for five years to the delivery of goods to the following conditions:

- Suitable storage
- Qualified staff install according to rules
- Supply with not corrosive water
- Greatest pressure of use: 8 bar
- Don't utilize the hemp on connections with washer o-ring
- Cleanliness with not corrosive detergents.

N.B. The warranty isn't valid, if the radiators are connected to heating installation with vessel open expansion.

The hole of Bari is competing for controversy.

All the measures are expressed in millimetres.

This document cancels previous document. Without notice, Metalform Design Srls has the right to modify models and measures.

# scheda anagrafica cliente

agente		data	
ragione sociale			
indirizzo		n°	
c.a.p.	località		prov.
e-mail			
tel.		fax	
destinazione merce			
corrispondenza			
cod. fisc.			
part. iva			
banca d'appoggio			agenzia
cod. iban			
modalità di spedizione		ns. mezzo	vs. mezzo
ammistratore			tel./cell.
resp. acquisti			tel./cell.

## TIPOLOGIA CLIENTE

<input type="checkbox"/> rivenditore	<input type="checkbox"/> studio tecnico / architetto
<input type="checkbox"/> rivenditore / esposizione	<input type="checkbox"/> materiali edili / esposizione
<input type="checkbox"/> impresa edile	<input type="checkbox"/> altro

## DICHIARAZIONE DI CONSENSO AL TRATTAMENTO DEI DATI PERSONALI (ART. 23 DEL D. LGS N° 196/03)

Il sottoscritto/a in qualità di titolare / legale rappresentante della ditta

Ricevuta l'informazione di cui all'art. 13 del D. LGS. N° 196/03, prende atto dei diritti riconosciuti all'intestatario dall'art. 7 del medesimo decreto, con la presente

ESPRIME

NEGA

Il suo consenso al trattamento dei dati personali nei limiti e nelle modalità descritte nell'informativa di cui sopra..

FIRMA CLIENTE

FIRMA AGENTE

TIMBRO

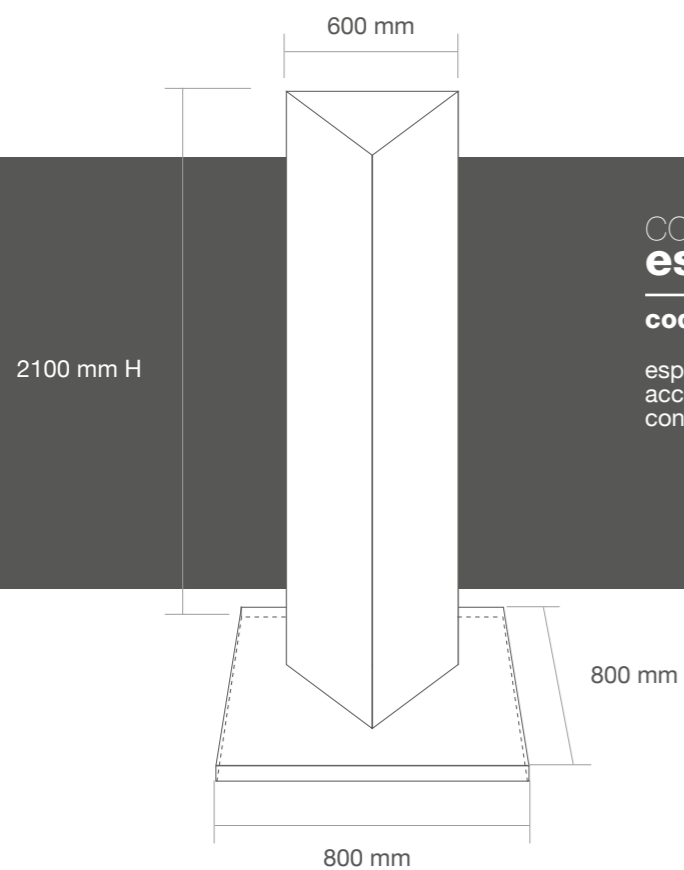

corner  
**espositivo**

**cod. CRN03**

espositore a 3 lati in  
acciaio verniciato nero opaco  
con logo aziendale serigrafato

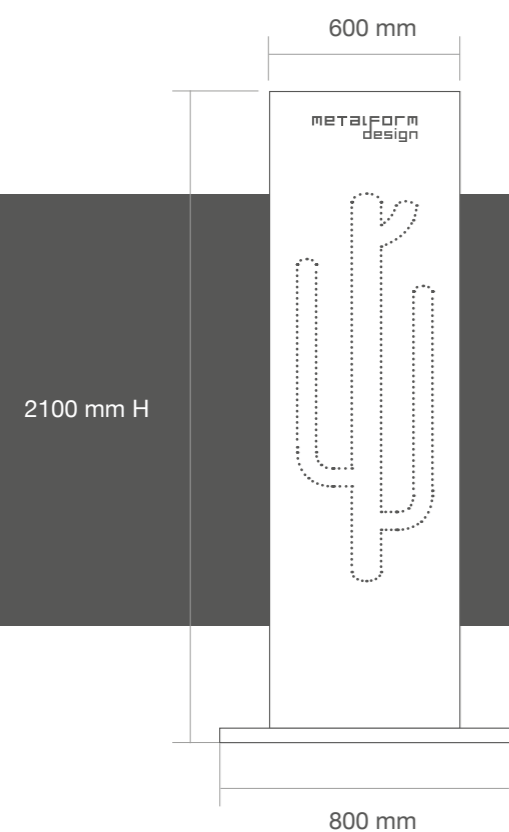

corner  
**espositivo**

**cod. CRN02**

espositore a 2 lati in  
acciaio verniciato nero opaco  
con logo aziendale serigrafato



# METALFORM design

Progettiamo da anni termoarredi con particolare attenzione ai dettagli e alla qualità. I prodotti Metalform Design nascono in Italia con gusto e stile italiano!

 70026 Modugno // (BA) ITALY  
Via dei Fabbri, 9/11  
 +39 080 535 4915  
+39 080 536 8692  
 [metalform@metalformdesign.it](mailto:metalform@metalformdesign.it)  
P.IVA 07705230725  
[www.metalformdesign.it](http://www.metalformdesign.it)